

→ Bearing insert

with set screws
UC200

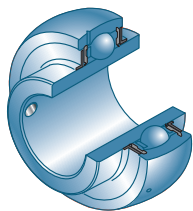

and extended sealing system
UC200L4

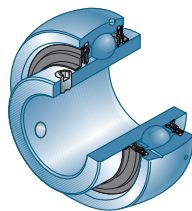

Shaft diameter	Bearing insert	Main dimensions [mm]					
		d mm	D	C	B1	s _{max}	D1
12	UC201G2	47,0	16,0	31,0	12,7	29,0	4,4
15	UC202G2	47,0	16,0	31,0	12,7	29,0	4,4
17	UC203G2	47,0	16,0	31,0	12,7	29,0	4,4
20	UC204G2	47,0	16,0	31,0	12,7	29,0	4,4
25	UC205G2	52,0	17,0	34,0	14,3	34,0	4,3
30	UC206G2	62,0	19,0	38,1	15,9	40,3	5,0
35	UC207G2	72,0	20,0	42,9	17,5	48,0	5,8
40	UC208G2	80,0	21,0	49,2	19,0	53,0	6,3
45	UC209G2	85,0	22,0	49,2	19,0	57,2	6,8
50	UC210G2	90,0	23,0	51,6	19,0	61,8	6,5
55	UC211G2	100,0	25,0	55,6	22,2	69,0	7,2
60	UC212G2	110,0	27,0	65,1	25,4	74,9	8,2
65	UC213G2	120,0	28,0	65,1	25,4	82,0	8,0
70	UC214G2	125,0	30,0	74,6	30,2	86,5	9,0
75	UC215G2	130,0	30,0	77,8	33,3	91,5	9,0
80	UC216G2	140,0	33,0	82,6	33,3	98,0	10,3
85	UC217G2	150,0	35,0	85,7	34,1	105,1	11,0
90	UC218G2	160,0	37,0	96,0	39,7	111,0	12,0

12	UC201G2L4	47,0	16,0	31,0	12,7	29,0	4,4
15	UC202G2L4	47,0	16,0	31,0	12,7	29,0	4,4
17	UC203G2L4	47,0	16,0	31,0	12,7	29,0	4,4
20	UC204G2L4	47,0	16,0	31,0	12,7	29,0	4,4
25	UC205G2L4	52,0	17,0	34,0	14,3	34,0	4,3
30	UC206G2L4	62,0	19,0	38,1	15,9	40,3	5,0
35	UC207G2L4	72,0	20,0	42,9	17,5	48,0	5,8
40	UC208G2L4	80,0	21,0	49,2	19,0	53,0	6,3
45	UC209G2L4	85,0	22,0	49,2	19,0	57,2	6,8
50	UC210G2L4	90,0	23,0	51,6	19,0	61,8	6,5

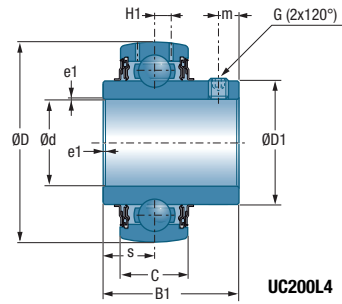
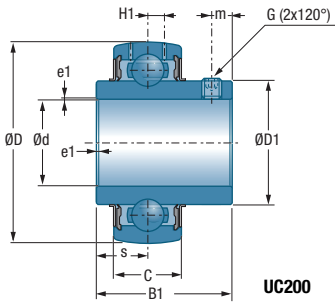

Main dimensions [mm]

Main dimensions [mm]				Dynamic load rating	Static load rating	Weight	Shaft diameter
m	G	a*	e1	C_r [kN]	C_{0r} [kN]	kg	d mm
4,7	M6x1	3,0	0,6	12,80	6,65	0,21	12
4,7	M6x1	3,0	0,6	12,80	6,65	0,20	15
4,7	M6x1	3,0	0,6	12,80	6,65	0,18	17
4,7	M6x1	3,0	0,6	12,80	6,65	0,17	20
5,5	M6x1	3,0	0,6	14,00	7,88	0,21	25
5,5	M6x1	3,0	0,6	19,50	11,20	0,32	30
6,5	M8x1	4,0	1,1	25,70	15,20	0,47	35
8,0	M8x1	4,0	1,1	29,60	18,20	0,64	40
8,0	M8x1	4,0	1,1	31,85	20,80	0,68	45
9,0	M10x1,25	5,0	1,1	35,10	23,20	0,80	50
9,0	M10x1,25	5,0	1,1	43,55	29,20	1,12	55
10,5	M10x1,25	5,0	1,1	52,50	32,80	1,53	60
12,0	M12x1,25	6,0	1,5	57,20	40,00	1,86	65
12,0	M12x1,25	6,0	2,0	62,00	45,00	2,05	70
12,0	M12x1,25	6,0	2,0	66,00	49,50	2,21	75
14,0	M12x1,25	6,0	2,0	72,50	54,20	2,79	80
14,0	M12x1,25	6,0	2,0	83,20	63,80	3,38	85
14,0	M12x1,25	6,0	2,0	96,00	71,50	4,45	90
5,0	M6x1	3,0	0,6	12,80	6,65	0,29	12
5,0	M6x1	3,0	0,6	12,80	6,65	0,27	15
5,0	M6x1	3,0	0,6	12,80	6,65	0,25	17
5,0	M6x1	3,0	0,6	12,80	6,65	0,22	20
5,0	M6x1	3,0	0,6	14,00	7,88	0,21	25
6,0	M6x1	3,0	0,6	19,50	11,20	0,32	30
6,5	M8x1	4,0	1,1	25,70	15,20	0,47	35
6,5	M8x1	4,0	1,1	29,60	18,20	0,64	40
6,5	M8x1	4,0	1,1	31,85	20,80	0,88	45
6,5	M8x1	4,0	1,1	35,10	23,20	0,15	50

* Width across flats (hexagon socket)



→ Bearing insert

with set screws
US200

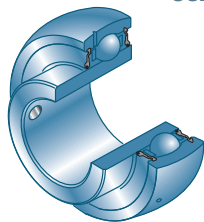

with tight fit
non-relubricatable
CS200

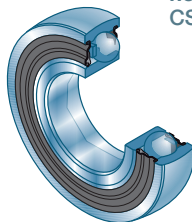

d mm	Bearing insert	Main dimensions [mm]					
		D	C	B1	s _{max}	D1	H1
12	US201G2	40,0	12,0	22,0	6,0	24,6	3,6
15	US202G2	40,0	12,0	22,0	6,0	24,6	3,6
17	US203G2	40,0	12,0	22,0	6,0	24,6	3,6
20	US204G2	47,0	14,0	25,0	7,0	29,0	4,0
25	US205G2	52,0	15,0	27,0	7,5	34,0	4,3
30	US206G2	62,0	16,0	30,0	8,0	40,3	5,0
35	US207G2	72,0	17,0	32,0	8,5	48,0	5,7
40	US208G2	80,0	18,0	34,0	9,0	53,0	6,2
45	US209G2	85,0	19,0	41,2	10,2	57,2	6,5
50	US210G2	90,0	20,0	43,5	10,9	61,8	6,5
55	US211G2	100,0	23,0	45,3	11,8	69,0	7,2
60	US212G2	110,0	24,0	53,7	14,9	74,9	8,0

12	CS201	40	12			24,6	
15	CS202	40	12			24,6	
17	CS203	40	12			24,6	
20	CS204	47	14			29,0	
25	CS205	52	15			34,0	
30	CS206	62	16			40,3	
35	CS207	72	17			48,0	
40	CS208	80	18			53,0	
45	CS209	85	19			57,2	
50	CS210	90	20			61,8	

Ød* : Inner ring bore according ISO 492 rather DIN 620-2

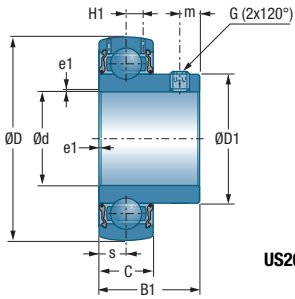

US200

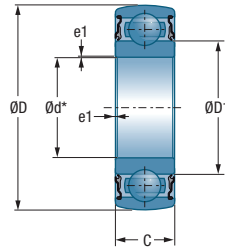

CS200

Main dimensions [mm]

Main dimensions [mm]				Dynamic load rating	Static load rating	Weight	Shaft diameter
m	G	a*	e1	C_r [kN]	C_{0r} [kN]	kg	d mm
4,0	M5x0,8	2,5	0,6	9,55	4,78	0,09	12
4,0	M5x0,8	2,5	0,6	9,55	4,78	0,08	15
4,0	M5x0,8	2,5	0,6	9,55	4,78	0,10	17
5,0	M6x1	3,0	0,6	12,80	6,65	0,13	20
5,5	M6x1	3,0	0,6	14,00	7,88	0,17	25
6,0	M6x1	3,0	0,6	19,50	11,20	0,27	30
6,5	M6x1	3,0	0,6	25,70	15,20	0,42	35
7,0	M8x1	4,0	1,1	29,60	18,20	0,60	40
8,2	M8x1	4,0	1,1	31,85	20,80	0,65	45
9,2	M8x1	4,0	1,1	35,10	23,20	0,76	50
9,8	M10x1,25	5,0	1,1	43,55	29,20	1,07	55
9,8	M10x1,25	5,0	1,1	52,50	32,80	1,30	60

* Width across flats (hexagon socket)

	0,6	9,58	4,78	0,065	12
	0,6	9,58	4,78	0,060	15
	0,6	9,58	4,78	0,050	17
	0,6	12,80	6,65	0,095	20
	0,6	14,00	7,88	0,110	25
	0,6	19,50	11,50	0,180	30
	0,6	25,50	15,20	0,250	35
	1,1	29,60	18,20	0,320	40
	1,1	31,50	20,80	0,370	45
	1,1	35,1	23,20	0,410	50



→ Bearing insert

with eccentric locking collar

ES200

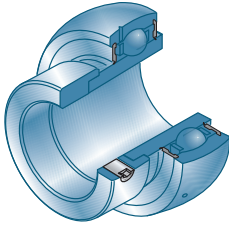

d mm	Bearing insert	Main dimensions [mm]						
		D	C	B1	J2	B	s _{max}	D2
12	ES201G2	40	12	19,1	13,5	28,6	6,5	27,2
15	ES202G2	40	12	19,1	13,5	28,6	6,5	27,2
17	ES203G2	40	12	19,1	13,5	28,6	6,5	27,2
20	ES204G2	47	14	21,4	13,5	30,9	7,5	32,4
25	ES205G2	52	15	21,4	13,5	30,9	7,5	37,4
30	ES206G2	62	16	23,8	15,9	35,7	9,0	44,1
35	ES207G2	72	17	25,4	17,5	38,9	9,5	51,1
40	ES208G2	80	18	30,2	18,3	43,7	11,0	58,0
45	ES209G2	85	19	30,2	18,3	43,7	11,0	63,5
50	ES210G2	90	20	30,2	18,3	43,7	11,0	67,2
55	ES211G2	100	24	32,5	20,7	48,4	12,0	74,5
60	ES212G2	110	24	33,4	22,3	49,3	12,0	82,0

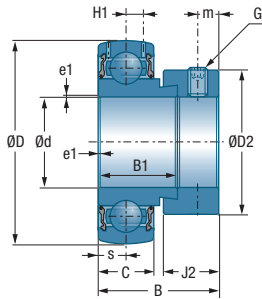

Main dimensions [mm]

Main dimensions [mm]					Dynamic load rating	Static load rating	Weight	Shaft diameter
H1	m	G	a*	e1	C_r [kN]	C_{0r} [kN]	kg	d mm
3,6	5,0	M6x1	3	0,6	9,55	4,78	0,14	12
3,6	5,0	M6x1	3	0,6	9,55	4,78	0,13	15
3,6	5,0	M6x1	3	0,6	9,55	4,78	0,13	17
4,0	5,0	M6x1	3	0,6	12,80	6,65	0,15	20
4,3	5,0	M6x1	3	0,6	14,00	7,88	0,19	25
5,0	6,0	M8x1	3	0,6	19,50	11,20	0,33	30
5,7	6,5	M8x1	4	1,1	25,70	15,20	0,50	35
6,2	6,5	M8x1	4	1,1	29,60	18,20	0,65	40
6,5	6,5	M8x1	4	1,1	31,85	20,80	0,69	45
6,5	6,5	M8x1	4	1,1	35,10	23,20	0,80	50
7,2	8,0	M10x1,25	5	1,1	43,55	29,20	0,87	55
8,0	8,0	M10x1,25	5	1,1	52,50	32,80	1,20	60

* Width across flats (hexagon socket)



→ Bearing insert

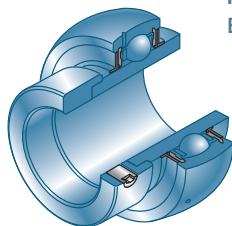

with eccentric locking collar
EX200

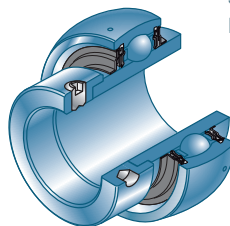

and extended sealing system
EX200L4

d mm	Bearing insert	Main dimensions [mm]						
		D	C	B1	J2	B	s _{max}	D2
12	EX201G2	47	16	34,0	13,5	43,5	17,0	32,4
15	EX202G2	47	16	34,0	13,5	43,5	17,0	32,4
17	EX203G2	47	16	34,0	13,5	43,5	17,0	32,4
20	EX204G2	47	16	34,0	13,5	43,5	17,0	32,4
25	EX205G2	52	17	34,8	13,5	44,3	17,4	37,4
30	EX206G2	62	19	36,4	15,9	48,3	18,2	44,1
35	EX207G2	72	20	37,6	17,5	51,1	18,8	51,1
40	EX208G2	80	21	42,8	18,3	56,3	21,4	58,0
45	EX209G2	85	22	42,8	18,3	56,3	21,4	63,5
50	EX210G2	90	23	49,2	18,3	62,7	24,6	67,2
55	EX211G2	100	25	55,4	20,7	71,3	27,7	74,5
60	EX212G2	110	27	61,8	22,3	77,7	30,9	82,0
65	EX213G2	120	28	68,2	23,5	85,7	34,1	86,0
70	EX214G2	125	30	68,2	23,5	85,7	34,1	96,8
75	EX215G2	130	30	74,6	23,9	92,1	37,3	102,0
80	EX216G2	140	33	74,6	27,0	95,2	37,3	110,0
85	EX217G2	150	35	53,2	27,0	73,2	23,4	119,0
90	EX218G2	160	37	55,0	24,0	72,5	24,5	120,0

12	EX201G2L4	47	16	34,0	13,5	43,5	17,0	32,4
15	EX202G2L4	47	16	34,0	13,5	43,5	17,0	32,4
17	EX203G2L4	47	16	34,0	13,5	43,5	17,0	32,4
20	EX204G2L4	47	16	34,0	13,5	43,5	17,0	32,4
25	EX205G2L4	52	17	34,8	13,5	44,3	17,4	37,4
30	EX206G2L4	62	19	36,4	15,9	48,3	18,2	44,1
35	EX207G2L4	72	20	37,6	17,5	51,1	18,8	51,1
40	EX208G2L4	80	21	42,8	18,3	56,3	21,4	58,0
45	EX209G2L4	85	22	42,8	18,3	56,3	21,4	63,5
50	EX210G2L4	90	23	49,2	18,3	62,7	24,6	67,2

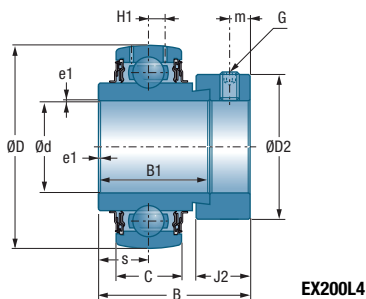
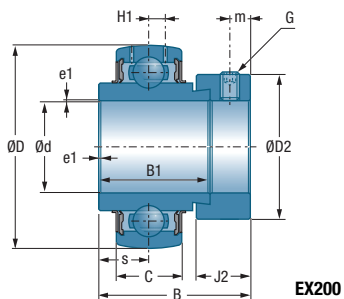

Main dimensions [mm]

Main dimensions [mm]					Dynamic load rating	Static load rating	Weight	Shaft diameter
H1	m	G	a*	e1	C_r [kN]	C_{0r} [kN]	kg	d mm
4,4	5,0	M6x1	3	0,6	12,80	6,65	0,29	12
4,4	5,0	M6x1	3	0,6	12,80	6,65	0,27	15
4,4	5,0	M6x1	3	0,6	12,80	6,65	0,25	17
4,4	5,0	M6x1	3	0,6	12,80	6,65	0,22	20
4,3	5,0	M6x1	3	0,6	14,00	7,88	0,25	25
5,0	6,0	M6x1	3	0,6	19,50	11,20	0,41	30
5,8	6,5	M8x1	4	1,1	25,70	15,20	0,60	35
6,3	6,5	M8x1	4	1,1	29,60	18,20	0,78	40
6,8	6,5	M8x1	4	1,1	31,85	20,80	0,87	45
6,5	6,5	M8x1	4	1,1	35,10	23,20	1,01	50
7,2	8,0	M10x1,25	5	1,5	43,55	29,20	1,39	55
8,2	8,0	M10x1,25	5	1,5	52,50	32,80	1,87	60
8,0	8,5	M10x1,25	5	1,5	57,20	40,00	2,41	65
9,0	8,5	M10x1,25	5	2,0	62,00	45,00	2,57	70
9,0	8,5	M10x1,25	5	2,0	66,00	49,50	2,84	75
10,3	10,3	M12x1,25	6	2,0	72,50	54,20	3,12	80
11,0	10,0	M12x1,25	6	2,0	83,20	63,80	3,72	85
12,0	9,5	M12x1,25	6	2,0	96,00	71,50	4,90	90

4,4	5,0	M6x1	3	0,6	12,80	6,65	0,31	12
4,4	5,0	M6x1	3	0,6	12,80	6,65	0,29	15
4,4	5,0	M6x1	3	0,6	12,80	6,65	0,27	17
4,4	5,0	M6x1	3	0,6	12,80	6,65	0,24	20
4,3	5,0	M6x1	3	0,6	14,00	7,88	0,27	25
5,0	6,0	M6x1	3	0,6	19,50	11,20	0,42	30
5,8	6,5	M8x1	4	1,1	25,70	15,20	0,63	35
6,3	6,5	M8x1	4	1,1	29,60	18,20	0,80	40
6,8	6,5	M8x1	4	1,1	31,85	20,80	0,90	45
6,5	6,5	M8x1	4	1,1	35,10	23,20	1,10	50

* Width across flats (hexagon socket)



→ Bearing insert

with adapter sleeve

UK200H

LK200H (light-weight design)

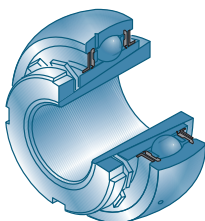

d mm	Shaft diameter	Bearing insert + adapter sleeve	Main dimensions [mm]							
			D	C	B1	c	B	d1	D1	D2
20	UK205G2H		52	17	21	8,0	35	25	34,0	38
25	UK206G2H		62	19	25	8,0	38	30	40,3	45
30	UK207G2H		72	20	27	9,0	43	35	48,0	52
35	UK208G2H		80	21	29	10,0	46	40	53,0	58
40	UK209G2H		85	22	30	11,0	50	45	57,2	65
45	UK210G2H		90	23	31	12,0	55	50	61,8	70
50	UK211G2H		100	25	33	12,5	59	55	69,0	75
55	UK212G2H		110	27	36	13,0	62	60	74,9	80
60	UK213G2H		120	28	36	14,0	65	65	82,0	85
65	UK215G2H		130	30	41	15,0	73	75	91,5	98
70	UK216G2H		140	33	44	17,0	78	80	98,0	105
75	UK217G2H		150	35	44	18,0	82	85	105,1	110
80	UK218G2H		160	37	48	18,0	86	90	111,0	120

20	LK204G2H		47	14	15	9,0	28		30,9	32
25	LK205G2H		52	15	15	9,2	28		35,7	38
30	LK206G2H		62	18	18	10,7	32		43,0	45
35	LK207G2H		72	19	19	11,2	34		48,6	52
40	LK208G2H		80	21	22	12,2	38		55,0	58
45	LK209G2H		85	22	22	12,2	38		59,2	64
50	LK210G2H		90	22	22	14,2	40		64,2	70

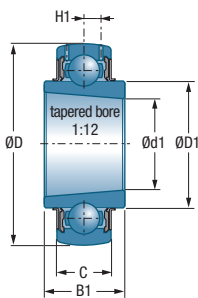

UK200 / LK200

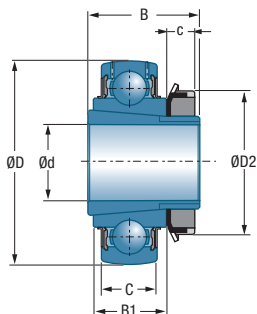

UK200H / LK200H

H1	Bearing insert	Adapter sleeve	Dynamic load rating C_r [kN]	Static load rating C_{Or} [kN]	Weight total of Bearing insert + adapter sleeve kg	Bearing insert weight kg	Shaft diameter d mm
4,3	UK205G2	H2305	14,00	7,88	0,24	0,15	20
5,0	UK206G2	H2306	19,50	11,20	0,38	0,25	25
5,8	UK207G2	H2307	25,70	15,20	0,54	0,37	30
6,3	UK208G2	H2308	29,60	18,20	0,70	0,48	35
6,8	UK209G2	H2309	31,85	20,80	0,81	0,53	40
6,5	UK210G2	H2310	35,10	23,20	0,95	0,59	45
7,2	UK211G2	H2311	43,55	29,20	1,19	0,77	50
8,2	UK212G2	H2312	52,50	32,80	1,51	1,03	55
8,0	UK213G2	H2313	57,20	40,00	1,92	1,36	60
9,0	UK215G2	H2315	66,00	49,50	2,72	1,67	65
10,3	UK216G2	H2316	72,50	54,20	3,24	1,96	70
11,0	UK217G2	H2317	83,20	63,80	3,87	2,42	75
12,0	UK218G2	H2318	96,00	71,50	4,69	3,00	80
4,0	LK204	HLK2304	12,70	6,60	0,14		20
4,3	LK205	HLK2305	13,60	7,80	0,17		25
5,0	LK206	HLK2306	18,90	11,30	0,28		30
5,7	LK207	HLK2307	24,90	15,30	0,40		35
6,2	LK208	HLK2308	29,50	19,80	0,54		40
6,5	LK209	HLK2309	31,85	19,80	0,57		45
6,5	LK210	HLK2310	33,00	19,90	0,68		50

For the size of the appropriate hook spanner refer on page 22 in our ball bearing catalogue (TC09).

→ Bearing insert

with rubber damping ring

ESR200, CESR200

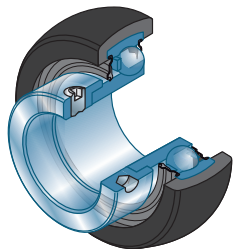

Form: spherical

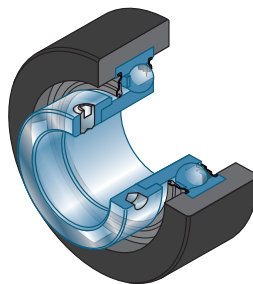

Form: cylindrical

d mm	Unit	Bearing insert	rubber damping ring	Form	Main dimensions [mm]			
					D	D ₃	C _D	C
12	ESR201B	ES201SRS	SRBB203	spherical	40	47,3	17,6	12,0
15	ESR202B	ES202SRS	SRBB203	spherical	40	47,3	17,6	12,0
20	ESR204B	ES204SRS	SRBB204	spherical	47	52,3	17,6	14,0
25	ESR205B	ES205SRS	SRBB205	spherical	52	62,2	20,8	15,0
30	ESR206B	ES206SRS	SRBB206	spherical	62	72,2	23,0	18,0
35	ESR207B	ES207SRS	SRBB207	spherical	72	80,2	24,0	19,0
40	ESR208B	ES208SRS	SRBB208	spherical	80	85,0	27,0	21,0
50	ESR210B	ES210SRS	SRBB210	spherical	90	100,2	30,0	22,0

15	CESR202A	CES202SRS	SRCA203	cylindrical	40	65,1	25,4	12,0
17	CESR203A	CES203SRS	SRCA203	cylindrical	40	65,1	25,4	12,0
20	CESR204A	CES204SRS	SRCA204	cylindrical	47	65,1	25,4	14,0
25	CESR205A	CES205SRS	SRCA205	cylindrical	52	65,1	25,4	15,0

- Rubber damping rings are intended to reduce noise and vibration
- Hardness of rubber: $70 \pm 5^\circ$ SHORE A / Material: NBR
- Filled with long life grease / non-relubricatable

- Reduced friction torque through optimized sealing lip
- Noise inspected
- Operating temperatures: -20°C up to $+85^\circ\text{C}$
- Inner- and eccentric ring zinc-plated

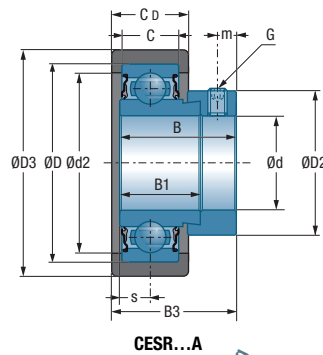
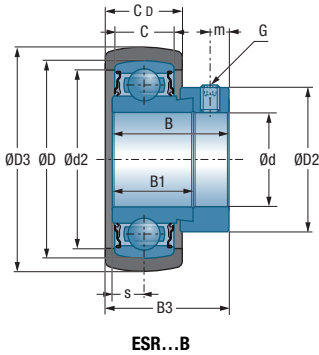

Main dimensions [mm]

B	B1	B3	D2	d2	s	m	G	Dynamic load rating		Static load rating		Weight unit [kg]	Shaft diameter d [mm]
								C_r [kN]	C_{0r} [kN]				
28,6	19,0	30,9	27,2	33,5	6,5	5,0	M6x1	9,55	4,78	0,16	12		
28,6	19,0	30,9	27,2	33,5	6,5	5,0	M6x1	9,55	4,78	0,15	15		
31,0	21,4	32,3	32,4	39,0	7,5	5,0	M6x1	12,80	6,65	0,18	20		
31,0	21,4	33,9	37,4	44,5	7,5	5,0	M6x1	14,00	7,88	0,22	25		
35,7	23,8	38,2	44,1	54,0	9,0	6,0	M8x1	19,50	11,20	0,37	30		
38,9	25,4	41,4	51,1	62,0	9,5	6,5	M8x1	25,70	15,20	0,54	35		
43,7	30,2	46,2	58,0	70,0	11,0	6,5	M8x1	29,60	18,20	0,68	40		
43,7	30,2	47,7	67,2	80,0	11,0	6,5	M8x1	35,10	23,20	0,88	50		

28,6	19,0	34,8	27,2	35,0	6,5	5,0	M6x1	9,55	4,78	0,21	15
28,6	19,0	34,8	27,2	35,0	6,5	5,0	M6x1	9,55	4,78	0,20	17
31,0	21,4	36,2	32,4	40,0	7,5	5,0	M6x1	12,80	6,65	0,22	20
31,0	21,4	36,2	37,4	46,0	7,5	5,0	M6x1	14,00	7,88	0,26	25



→ Bearing insert

with set screws

UC300

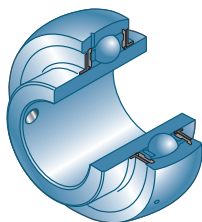

d mm	Bearing insert	Main dimensions [mm]					
		D	C	B1	s _{max}	D1	H1
25	UC305G2	62	21	38	15	35,4	6,2
30	UC306G2	72	24	43	17	44,6	6,5
35	UC307G2	80	25	48	19	48,9	7,2
40	UC308G2	90	28	52	19	56,5	8,5
45	UC309G2	100	30	57	22	61,8	9,0
50	UC310G2	110	32	61	22	68,7	9,9
55	UC311G2	120	34	66	25	74,9	10,6
60	UC312G2	130	36	71	26	81,0	11,3
65	UC313G2	140	38	75	30	87,5	12,1
70	UC314G2	150	40	78	33	94,0	12,8
75	UC315G2	160	42	82	32	100,5	13,5
80	UC316G2	170	44	86	34	107,9	14,5
85	UC317G2	180	46	96	40	114,0	15,5
90	UC318G2	190	48	96	40	120,0	16,5
95	UC319G2	200	50	103	41	126,5	16,7
100	UC320G2	215	54	108	42	134,5	19,0
105	UC321G2	225	57	112	44	140,5	20,0
110	UC322G2	240	60	117	46	149,0	21,0
120	UC324G2	260	64	126	51	163,0	22,0
130	UC326G2	280	68	135	54	177,0	23,0
140	UC328G2	300	73	145	59	190,0	25,0

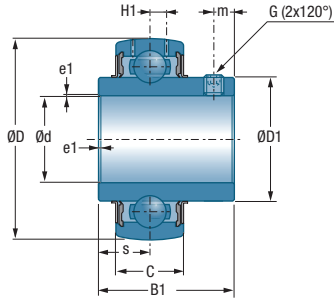

Main dimensions [mm]				Dynamic load rating	Static load rating	Weight	Shaft diameter
m	G	a*	e1	C_r [kN]	C_{0r} [kN]	kg	d mm
6,0	M6x1	3	1,5	22,36	11,50	0,35	25
6,0	M6x1	3	1,5	27,00	15,20	0,56	30
8,0	M8x1	4	2,0	33,50	19,20	0,71	35
10,0	M10x1,25	5	2,0	40,56	24,00	0,96	40
10,0	M10x1,25	5	2,0	53,00	31,80	1,28	45
12,0	M12x1,25	6	2,0	62,00	37,80	1,65	50
12,0	M12x1,25	6	2,0	71,50	44,80	1,90	55
12,0	M12x1,25	6	2,0	81,60	51,80	2,60	60
12,0	M12x1,25	6	2,0	93,86	60,50	3,25	65
12,0	M12x1,25	6	2,5	104,26	68,00	3,95	70
14,0	M14x1,5	6	2,5	113,36	76,80	4,33	75
14,0	M14x1,5	6	3,0	122,85	86,50	5,57	80
16,0	M16x1,5	8	3,0	132,60	96,50	6,84	85
16,0	M16x1,5	8	3,5	143,00	108,00	7,87	90
18,0	M16x1,5	8	3,0	156,00	122,00	8,91	95
18,0	M18x1,5	9	3,5	171,60	140,00	11,20	100
18,0	M18x1,5	9	3,0	182,00	155,00	12,20	105
18,0	M18x1,5	9	3,0	205,00	178,00	14,30	110
18,0	M18x1,5	9	3,0	228,00	208,00	18,50	120
20,0	M20x1,5	10	4,0	252,00	242,00	23,00	130
20,0	M20x1,5	10	4,0	275,00	272,00	28,50	140

* Width across flats (hexagon socket)



→ Bearing insert

with eccentric locking collar

EX300

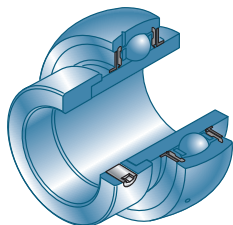

		Main dimensions [mm]						
Shaft diameter	Bearing insert	D	C	B1	J2	B	s_{max}	D2
d mm								
25	EX305G2	62	21	34,9	15,9	46,8	16,7	42,8
30	EX306G2	72	24	36,5	17,5	50,0	17,5	50,0
35	EX307G2	80	25	38,1	17,5	51,6	18,3	55,0
40	EX308G2	90	28	41,3	20,6	57,1	19,8	63,5
45	EX309G2	100	30	42,9	20,6	58,7	19,8	70,0
50	EX310G2	110	32	49,2	22,2	66,6	24,6	76,2
55	EX311G2	120	34	55,6	22,2	73,0	27,8	83,0
60	EX312G2	130	36	61,9	23,9	79,4	31,0	89,0
65	EX313G2	140	38	65,1	27,0	85,7	32,5	97,0
70	EX314G2	150	40	68,3	30,2	92,1	34,2	102,0
75	EX315G2	160	42	74,6	31,8	100,0	37,3	113,0
80	EX316G2	170	44	81,0	31,8	106,4	40,5	119,0
85	EX317G2	180	46	84,1	31,8	109,5	42,0	127,0
90	EX318G2	190	48	87,3	36,5	115,9	43,6	133,0
95	EX319G2	200	50	93,7	36,5	122,3	46,8	140,0
100	EX320G2	215	54	100,0	36,5	128,6	50,0	146,0

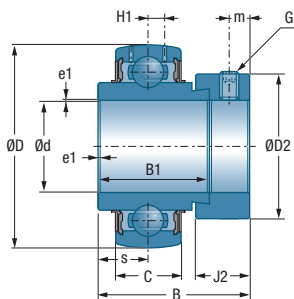

Main dimensions [mm]

Main dimensions [mm]					Dynamic load rating	Static load rating	Weight	Shaft diameter
H1	m	G	a*	e1	C_r [kN]	C_{0r} [kN]	kg	d mm
6,2	6,0	M8x1	4	1,5	22,36	11,50	0,43	25
6,5	6,7	M8x1	4	1,5	27,00	15,20	0,68	30
7,2	6,7	M8x1	4	2,0	33,50	19,20	0,80	35
8,5	8,0	M10x1,25	5	2,0	40,56	24,00	1,08	40
9,0	8,0	M10x1,25	5	2,0	53,00	31,80	1,45	45
9,9	8,7	M10x1,25	5	2,0	62,00	37,80	1,86	50
10,6	9,0	M10x1,25	5	2,0	71,50	44,80	2,30	55
11,3	9,0	M10x1,25	5	2,0	81,60	51,80	2,89	60
12,1	11,5	M12x1,25	6	2,0	93,86	60,50	3,66	65
12,8	12,0	M12x1,25	6	2,5	104,26	68,00	4,50	70
13,5	13,0	M16x1,5	8	2,5	113,36	76,80	5,34	75
14,5	13,0	M16x1,5	8	3,0	122,85	86,50	6,70	80
15,5	13,0	M16x1,5	8	3,0	132,60	96,50	7,96	85
16,5	14,5	M20x1,5	8	3,0	143,00	108,00	9,10	90
16,7	14,5	M20x1,5	8	3,0	156,00	122,00	10,40	95
19,0	14,5	M20x1,5	9	3,5	171,60	140,00	13,00	100

* Width across flats (hexagon socket)



→ Bearing insert

with adapter sleeve

UK300H

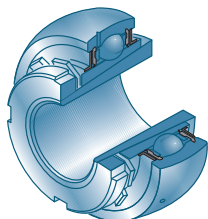

d mm	Shaft diameter	Bearing insert + adapter sleeve	Main dimensions [mm]							
			D	C	B1	c	B	d1	D1	D2
20	UK305G2H		62	21	27	8,0	35	25	35,4	38
25	UK306G2H		72	24	30	8,0	38	30	44,6	45
30	UK307G2H		80	25	33	9,0	43	35	48,9	52
35	UK308G2H		90	28	35	10,0	46	40	56,5	58
40	UK309G2H		100	30	38	11,0	50	45	61,8	65
45	UK310G2H		110	32	40	12,0	55	50	68,7	70
50	UK311G2H		120	34	43	12,5	59	55	74,9	75
55	UK312G2H		130	36	47	13,0	62	60	81,0	80
60	UK313G2H		140	38	49	14,0	65	65	87,5	85
65	UK315G2H		160	42	55	15,0	73	75	100,5	98
70	UK316G2H		170	44	55	17,0	78	80	107,9	105
75	UK317G2H		180	46	60	18,0	82	85	114,0	110
80	UK318G2H		190	48	60	18,0	86	90	120,0	120
85	UK319G2H		200	50	66	19,0	90	95	126,5	125
90	UK320G2H		215	54	68	20,0	97	100	134,5	130
100	UK322G2H		240	60	80	21,0	105	110	147,7	145
110	UK324G2H		260	64	86	22,0	112	120	162,1	155
115	UK326G2H		280	68	92	23,0	121	130	176,1	165
125	UK328G2H		300	72	98	24,0	131	140	189,0	180

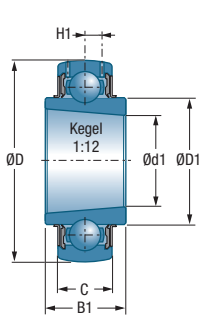

UK300

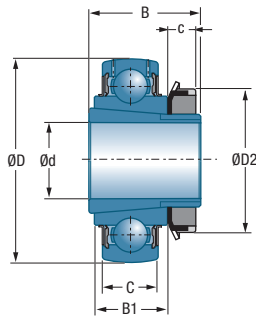

UK300H

	<i>Bearing insert</i>	<i>Adapter sleeve</i>	<i>Dynamic load rating</i>	<i>Static load rating</i>	<i>Weight total Bearing insert + adapter sleeve</i>	<i>Weight bearing insert</i>	<i>Shaft diameter</i>
H1			C_r [kN]	C_{0r} [kN]	kg	kg	d mm
6,2	UK305G2	H2305	22,36	11,50	0,49	0,40	20
6,5	UK306G2	H2306	27,00	15,20	0,59	0,46	25
7,2	UK307G2	H2307	33,50	19,20	0,92	0,75	30
8,5	UK308G2	H2308	40,56	24,00	1,03	0,81	35
9,0	UK309G2	H2309	53,00	31,80	1,47	1,19	40
9,9	UK310G2	H2310	62,00	37,80	1,74	1,38	45
10,6	UK311G2	H2311	71,50	44,80	2,20	1,78	50
11,3	UK312G2	H2312	81,60	51,80	2,54	2,06	55
12,1	UK313G2	H2313	93,86	60,50	3,27	2,71	60
13,5	UK315G2	H2315	113,36	76,80	5,03	3,98	65
14,5	UK316G2	H2316	122,85	86,50	5,83	4,55	70
15,5	UK317G2	H2317	132,60	96,50	6,89	5,44	75
16,5	UK318G2	H2318	143,00	108,00	7,94	6,25	80
16,7	UK319G2	H2319	156,00	122,00	9,23	7,31	85
19,0	UK320G2	H2320	171,60	140,00	10,97	8,82	90
21,0	UK322G2	H2322	205,00	178,00	17,64	14,90	100
22,0	UK324G2	H2324	228,00	208,00	21,19	18,00	110
23,0	UK326G2	H2326	252,00	242,00	27,90	23,30	115
25,0	UK328G2	H2328	275,00	272,00	34,45	28,90	125

For the size of the appropriate hook spanner refer on page 22 in our ball bearing catalogue (TC09).



→ Bearing insert

with cylindrical outer ring and set screws

CUC200

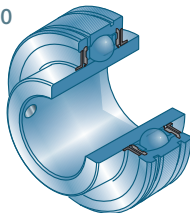

Shaft diameter	Bearing insert	Main dimensions [mm]							
d mm		D	C	B1	s _{max}	D1	H1	m	N
20	CUC204	47	17	31,0	12,7	29,0	4,0	4,5	1,35
25	CUC205	52	17	34,0	14,3	34,0	4,1	5,0	1,35
30	CUC206	62	19	38,1	15,9	40,3	4,2	5,5	1,90
35	CUC207	72	20	42,9	17,5	46,9	5,0	6,5	1,90
40	CUC208	80	21	49,2	19,0	53,0	5,0	8,0	1,90
45	CUC209	85	22	49,2	19,0	57,2	5,1	8,0	1,90
50	CUC210	90	23	51,6	19,0	61,8	5,6	9,0	2,70

CUS200

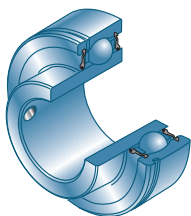

Shaft diameter	Bearing insert	Main dimensions [mm]							
d mm		D	C	B1	s _{max}	D1	m	N	
20	CUS204	47	14	25,0	7,0	28,3	5	1,35	
25	CUS205	52	15	27,0	7,5	34,0	5	1,35	
30	CUS206	62	16	30,0	8,0	40,0	5,5	1,90	
35	CUS207	72	17	32,0	8,5	46,9	6	1,90	
40	CUS208	80	18	34,0	9,0	52,4	8	1,90	
45	CUS209	85	19	41,2	9,5	57,6	8	1,90	
50	CUS210	90	20	43,5	10,0	63,2	9	2,70	

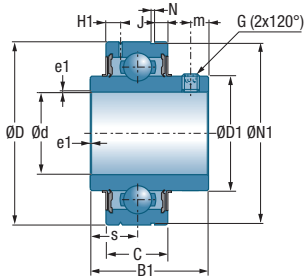

Main dimensions [mm]

Main dimensions [mm]					Dynamic load rating	Static load rating	Weight	Shaft diameter
J	N1	G	a*	e1	C_r [kN]	C_{0r} [kN]	kg	d mm
3,10	44,60	M6 x 1	3	0,6	12,80	6,65	0,20	20
3,20	49,73	M6 x 1	3	0,6	14,00	7,88	0,21	25
3,20	59,61	M6 x 1	3	0,6	19,50	11,20	0,35	30
3,30	68,81	M8 x 1	4	1,1	25,70	15,20	0,47	35
3,40	76,81	M8 x 1	4	1,1	29,60	18,20	0,64	40
3,50	81,81	M8 x 1	4	1,1	31,85	20,80	0,68	45
3,70	86,79	M10x1,25	5	1,1	35,10	23,20	0,80	50

* Width across flats (hexagon socket)

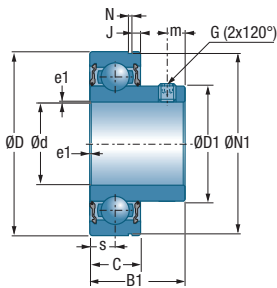

Main dimensions [mm]

Main dimensions [mm]					Dynamic load rating	Static load rating	Weight	Shaft diameter
J	N1	G	a*	e1	C_r [kN]	C_{0r} [kN]	kg	d mm
2,38	44,60	M6 x 1	3	1,0	12,80	6,65	0,13	20
2,38	49,73	M6 x 1	3	1,0	14,00	7,88	0,17	25
3,18	59,61	M6 x 1	3	1,0	19,50	11,20	0,27	30
3,18	68,81	M6 x 1	3	1,0	25,70	15,20	0,42	35
3,18	76,81	M8 x 1	4	1,0	29,60	18,20	0,48	40
3,18	81,81	M8 x 1	4	1,5	31,85	20,80	0,57	45
3,70	86,79	M8 x 1	4	1,5	35,10	23,20	0,66	50

* Width across flats (hexagon socket)

→ Bearing insert

with cylindrical outer ring and eccentric locking collar

CES200

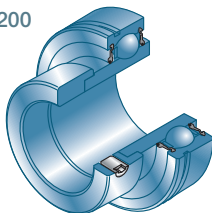

Shaft diameter	Bearing insert	Main dimensions [mm]								
		d mm	D	C	B1	J2	B	s _{max}	D2	m
20	CES204	47	14	21,5	13,5	31,0	7,0	33,3	5,0	1,35
25	CES205	52	15	21,5	13,5	31,0	7,5	38,1	5,0	1,35
30	CES206	62	16	23,8	15,9	35,7	8,0	44,5	6,0	1,90
35	CES207	72	17	25,4	17,5	38,9	8,5	55,6	6,5	1,90
40	CES208	80	18	30,2	18,3	43,7	9,0	60,3	6,5	1,90
45	CES209	85	19	30,2	18,3	43,7	9,5	63,5	6,5	1,90
50	CES210	90	20	30,2	18,3	43,7	10,0	69,9	6,5	2,70

CEX200

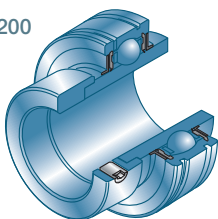

Shaft diameter	Bearing insert	Main dimensions [mm]								
		d mm	D	C	B1	J2	B	s _{max}	D2	H1
20	CEX204	47	17	34,2	13,5	43,7	17,1	33,3	4,0	5,0
25	CEX205	52	17	34,9	13,5	44,4	17,5	38,1	4,1	5,0
30	CEX206	62	19	36,5	15,9	48,4	18,3	44,5	4,2	6,0
35	CEX207	72	20	37,6	17,5	51,1	18,8	55,5	5,0	6,5
40	CEX208	80	21	42,8	18,3	56,3	21,4	60,3	5,0	6,5
45	CEX209	85	22	42,8	18,3	56,3	21,4	63,5	5,1	6,5
50	CEX210	90	24	49,2	18,3	62,7	24,6	69,5	5,6	6,5

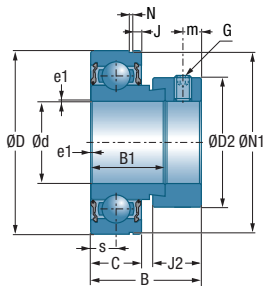

Main dimensions [mm]

Main dimensions [mm]					Dynamic load rating	Static load rating	Weight	Shaft diameter
J	N1	G	a*	e1	C_r [kN]	C_{0r} [kN]	kg	d mm
2,38	44,60	M6x1	3	1,0	12,80	6,65	0,15	20
2,38	49,73	M6x1	3	1,0	14,00	7,88	0,19	25
3,18	59,61	M6x1	3	1,0	19,50	11,20	0,33	30
3,18	68,81	M8x1	4	1,5	25,70	15,20	0,50	35
3,18	76,81	M8x1	4	1,5	29,60	18,20	0,65	40
3,18	81,81	M8x1	4	1,5	31,85	20,80	0,69	45
3,70	86,79	M8x1	4	1,5	35,10	23,20	0,80	50

* Width across flats (hexagon socket)

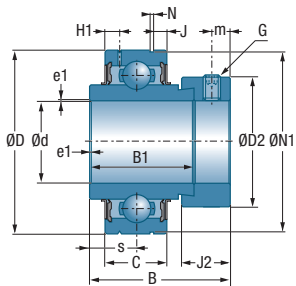

Main dimensions [mm]

Main dimensions [mm]						Dynamic load rating	Static load rating	Weight	Shaft diameter
N	J	N1	G	a*	e1	C_r [kN]	C_{0r} [kN]	kg	d mm
1,35	3,1	44,60	M6x1	3	1,0	12,80	6,65	0,22	20
1,35	3,2	49,73	M6x1	3	1,0	14,00	7,88	0,25	25
1,90	3,2	59,61	M6x1	3	1,0	19,50	11,20	0,41	30
1,90	3,3	68,81	M8x1	4	1,5	25,70	15,20	0,60	35
1,90	3,4	76,81	M8x1	4	1,5	29,60	18,20	0,78	40
1,90	3,5	81,81	M8x1	4	1,5	31,85	20,80	0,87	45
2,70	3,7	86,79	M8x1	4	1,5	35,10	23,20	1,01	50

* Width across flats (hexagon socket)

→ Bearing insert - inch

with set screws

UC200

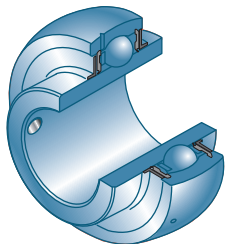

Shaft diameter		Bearing insert		Main dimensions [mm]			
d inch		D	C	B1	s _{max}	D1	H1
1/2	UC201-08G2	47	16	31,0	12,7	29,0	4,4
5/8	UC202-10G2	47	16	31,0	12,7	29,0	4,4
11/16	UC203-11G2	47	16	31,0	12,7	29,0	4,4
3/4	UC204-12G2	47	16	31,0	12,7	29,0	4,4
7/8	UC205-14G2	52	17	34,0	14,3	34,0	4,3
15/16	UC205-15G2	52	17	34,0	14,3	34,0	4,3
1	UC205-16G2	52	17	34,0	14,3	34,0	4,3
1 1/8	UC206-18G2	62	19	38,1	15,9	40,3	5,0
1 3/16	UC206-19G2	62	19	38,1	15,9	40,3	5,0
1 1/4	UC206-20G2	62	19	38,1	15,9	40,3	5,0
1 3/8	UC207-22G2	72	20	42,9	17,5	48,0	5,8
1 7/16	UC207-23G2	72	20	42,9	17,5	48,0	5,8
1 1/2	UC208-24G2	80	21	49,2	19,0	53,0	6,3
1 5/8	UC209-26G2	85	22	49,2	19,0	57,2	6,8
1 11/16	UC209-27G2	85	22	49,2	19,0	57,2	6,8
1 3/4	UC209-28G2	85	22	49,2	19,0	57,2	6,8
1 7/8	UC210-30G2	90	23	51,6	19,0	61,8	6,5
1 15/16	UC210-31G2	90	23	51,6	19,0	61,8	6,5
2	UC211-32G2	100	25	55,6	22,2	69,0	7,2
2 3/16	UC211-35G2	100	25	55,6	22,2	69,0	7,2
2 1/4	UC212-36G2	110	27	65,1	25,4	74,9	8,2
2 7/16	UC212-39G2	110	27	65,1	25,4	74,9	8,2
2 1/2	UC213-40G2	120	28	65,1	25,4	82,0	8,0
2 11/16	UC214-43G2	125	30	74,6	30,2	86,5	9,0
2 3/4	UC214-44G2	125	30	74,6	30,2	86,5	9,0
2 15/16	UC215-47G2	130	30	77,8	33,3	91,5	9,0
3	UC215-48G2	130	30	77,8	33,3	91,5	9,0
3 1/4	UC217-52G2	150	35	85,7	34,1	105,1	11,0
3 1/2	UC218-56G2	160	37	96,0	39,7	111,0	12,0

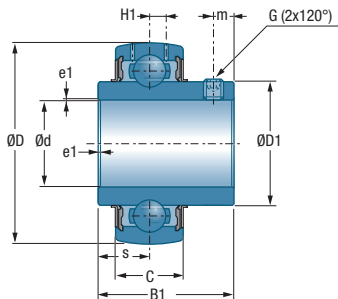

Main dimensions [mm]				Dynamic load rating	Static load rating	Weight	Shaft diameter
m	G	a* inch	e1	C _r [kN]	C _{0r} [kN]	kg	d inch
4,7	1/4-28UNF	1/8	0,6	12,80	6,65	0,21	1/2
4,7	1/4-28UNF	1/8	0,6	12,80	6,65	0,20	5/8
4,7	1/4-28UNF	1/8	0,6	12,80	6,65	0,18	11/16
4,7	1/4-28UNF	1/8	0,6	12,80	6,65	0,17	3/4
5,5	1/4-28UNF	1/8	0,6	14,00	7,88	0,21	7/8
5,5	1/4-28UNF	1/8	0,6	14,00	7,88	0,21	15/16
5,5	1/4-28UNF	1/8	0,6	14,00	7,88	0,20	1
5,5	1/4-28UNF	1/8	0,6	19,50	11,20	0,34	1 1/8
5,5	1/4-28UNF	1/8	0,6	19,50	11,20	0,31	1 3/16
5,5	1/4-28UNF	1/8	0,6	19,50	11,20	0,30	1 1/4
6,5	5/16-24UNF	5/32	1,1	25,70	15,20	0,48	1 3/8
6,5	5/16-24UNF	5/32	1,1	25,70	15,20	0,45	1 7/16
8,0	5/16-24UNF	5/32	1,1	29,60	18,20	0,68	1 1/2
8,0	5/16-24UNF	5/32	1,1	31,85	20,80	0,78	1 5/8
8,0	5/16-24UNF	5/32	1,1	31,85	20,80	0,74	1 11/16
8,0	5/16-24UNF	5/32	1,1	31,85	20,80	0,70	1 3/4
9,0	3/8-24UNF	3/16	1,1	35,10	23,20	0,87	1 7/8
9,0	3/8-24UNF	3/16	1,1	35,10	23,20	0,82	1 15/16
9,0	3/8-24UNF	3/16	1,1	43,55	29,20	1,27	2
9,0	3/8-24UNF	3/16	1,1	43,55	29,20	1,10	2 3/16
10,5	3/8-24UNF	3/16	1,1	52,50	32,80	1,67	2 1/4
10,5	3/8-24UNF	3/16	1,1	52,50	32,80	1,45	2 7/16
12,0	3/8-24UNF	3/16	1,5	57,20	40,00	1,94	2 1/2
12,0	3/8-24UNF	3/16	2,0	62,00	45,00	2,02	2 11/16
12,0	7/16-20UNF	7/32	2,0	62,00	45,00	2,06	2 3/4
12,0	7/16-20UNF	7/32	2,0	66,00	49,50	2,30	2 15/16
12,0	7/16-20UNF	7/32	2,0	66,00	49,50	2,13	3
14,0	7/16-20UNF	7/32	2,0	83,20	63,80	3,32	3 1/4
14,0	1/2-20UNF	1/4	2,0	96,00	71,50	4,56	3 1/2

* Width across flats (hexagon socket)



→ Bearing insert - inch

with set screws

US200

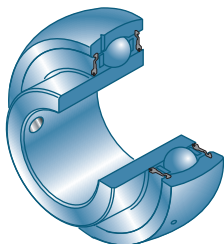

Shaft diameter		Bearing insert		Main dimensions [mm]			
d inch		D	C	B1	s _{max}	D1	H1
1/2	US201-08G2	40	12	22,0	6,0	24,6	3,6
5/8	US202-10G2	40	12	22,0	6,0	24,6	3,6
11/16	US203-11G2	40	12	22,0	6,0	24,6	3,6
3/4	US204-12G2	47	14	25,0	7,0	29,0	4,0
7/8	US205-14G2	52	15	27,0	7,5	34,0	4,3
15/16	US205-15G2	52	15	27,0	7,5	34,0	4,3
1	US205-16G2	52	15	27,0	7,5	34,0	4,3
1 1/8	US206-18G2	62	16	30,0	8,0	40,3	5,0
1 3/16	US206-19G2	62	16	30,0	8,0	40,3	5,0
1 1/4	US206-20G2	62	16	30,0	8,0	40,3	5,0
1 3/8	US207-22G2	72	17	32,0	8,5	48,0	5,7
1 7/16	US207-23G2	72	17	32,0	8,5	48,0	5,7
1 1/2	US208-24G2	80	18	34,0	9,0	53,0	6,2
1 5/8	US209-26G2	85	19	41,2	10,2	57,2	6,5
1 11/16	US209-27G2	85	19	41,2	10,2	57,2	6,5
1 3/4	US209-28G2	85	19	41,2	10,2	57,2	6,5
1 7/8	US210-30G2	90	20	43,5	10,9	61,8	6,5
1 15/16	US210-31G2	90	20	43,5	10,9	61,8	6,5
2	US211-32G2	100	23	45,3	11,8	69,0	7,2
2 3/16	US211-35G2	100	23	45,3	11,8	69,0	7,2
2 1/4	US212-36G2	110	24	53,7	14,9	74,9	8,0
2 7/16	US212-39G2	110	24	53,7	14,9	74,9	8,0

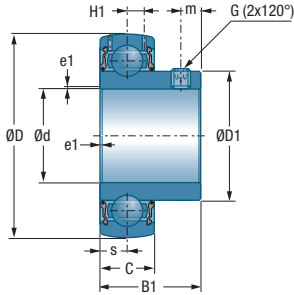

Main dimensions [mm]

Main dimensions [mm]				Dynamic load rating	Static load rating	Weight	Shaft diameter
m	G	a* inch	e1	C _r [kN]	C _{0r} [kN]	kg	d inch
4,0	10-32UNF	3/32	0,6	9,55	4,78	0,09	1/2
4,0	10-32UNF	3/32	0,6	9,55	4,78	0,08	5/8
4,0	10-32UNF	3/32	0,6	9,55	4,78	0,10	11/16
5,0	1/4-28UNF	1/8	0,6	12,80	6,65	0,13	3/4
5,5	1/4-28UNF	1/8	0,6	14,00	7,88	0,18	7/8
5,5	1/4-28UNF	1/8	0,6	14,00	7,88	0,18	15/16
5,5	1/4-28UNF	1/8	0,6	14,00	7,88	0,16	1
6,0	1/4-28UNF	1/8	0,6	19,50	11,20	0,28	1 1/8
6,0	1/4-28UNF	1/8	0,6	19,50	11,20	0,25	1 3/16
6,0	1/4-28UNF	1/8	0,6	19,50	11,20	0,24	1 1/4
6,5	5/16-24UNF	5/32	0,6	25,70	15,20	0,38	1 3/8
6,5	5/16-24UNF	5/32	0,6	25,70	15,20	0,37	1 7/16
7,0	5/16-24UNF	5/32	1,1	29,60	18,20	0,60	1 1/2
8,2	5/16-24UNF	5/32	1,1	31,85	20,80	0,75	1 5/8
8,2	5/16-24UNF	5/32	1,1	31,85	20,80	0,72	1 11/16
8,2	5/16-24UNF	5/32	1,1	31,85	20,80	0,67	1 3/4
9,2	5/16-24UNF	5/32	1,1	35,10	23,20	0,80	1 7/8
9,2	5/16-24UNF	5/32	1,1	35,10	23,20	0,78	1 15/16
9,8	5/16-24UNF	5/32	1,1	43,55	29,20	1,10	2
9,8	5/16-24UNF	5/32	1,1	43,55	29,20	1,05	2 3/16
9,8	3/8-24UNF	3/16	1,1	52,50	32,80	1,30	2 1/4
9,8	3/8-24UNF	3/16	1,1	52,50	32,80	1,22	2 7/16

* Width across flats (hexagon socket)



→ Bearing insert - inch

with eccentric locking collar

ES200

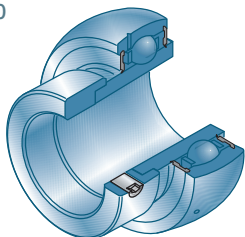

Shaft diameter Bearing insert		Main dimensions [mm]							
		D	C	B1	J2	B	s _{max}	D2	H1
d inch									
1/2	ES201-08G2	40	12	19,1	13,5	28,6	6,5	27,2	3,6
5/8	ES202-10G2	40	12	19,1	13,5	28,6	6,5	27,2	3,6
11/16	ES203-11G2	40	12	19,1	13,5	28,6	6,5	27,2	3,6
3/4	ES204-12G2	47	14	21,4	13,5	30,9	7,5	32,4	4,0
7/8	ES205-14G2	52	15	21,4	13,5	30,9	7,5	37,4	4,3
15/16	ES205-15G2	52	15	21,4	13,5	30,9	7,5	37,4	4,3
1	ES205-16G2	52	15	21,4	13,5	30,9	7,5	37,4	4,3
1 1/8	ES206-18G2	62	16	23,8	15,9	35,7	9,0	44,1	5,0
1 3/16	ES206-19G2	62	16	23,8	15,9	35,7	9,0	44,1	5,0
1 1/4	ES206-20G2	62	16	23,8	15,9	35,7	9,0	44,1	5,0
1 3/8	ES207-22G2	72	17	25,4	17,5	38,9	9,5	51,1	5,7
1 7/16	ES207-23G2	72	17	25,4	17,5	38,9	9,5	51,1	5,7
1 1/2	ES208-24G2	80	18	30,2	18,3	43,7	11,0	58,0	6,2
1 5/8	ES209-26G2	85	19	30,2	18,3	43,7	11,0	63,5	6,5
1 11/16	ES209-27G2	85	19	30,2	18,3	43,7	11,0	63,5	6,5
1 3/4	ES209-28G2	85	19	30,2	18,3	43,7	11,0	63,5	6,5
1 7/8	ES210-30G2	90	20	30,2	18,3	43,7	11,0	67,2	6,5
1 15/16	ES210-31G2	90	20	30,2	18,3	43,7	11,0	67,2	6,5
2	ES211-32G2	100	24	32,5	20,7	48,4	12,0	74,5	7,2
2 3/16	ES211-35G2	100	24	32,5	20,7	48,4	12,0	74,5	7,2
2 1/4	ES212-36G2	110	24	33,4	22,3	49,3	12,0	82,0	8,0
2 7/16	ES212-39G2	110	24	33,4	22,3	49,3	12,0	82,0	8,0

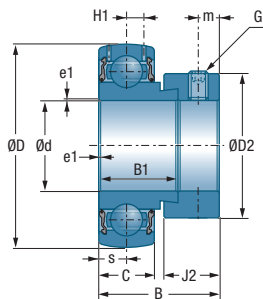

Main dimensions [mm]

Main dimensions [mm]				Dynamic load rating	Static load rating	Weight	Shaft diameter
m	G	a* inch	e1	C _r [kN]	C _{0r} [kN]	kg	d inch
5,0	1/4-28UNF	1/8	0,6	9,55	4,78	0,14	1/2
5,0	1/4-28UNF	1/8	0,6	9,55	4,78	0,13	5/8
5,0	1/4-28UNF	1/8	0,6	9,55	4,78	0,13	11/16
5,0	1/4-28UNF	1/8	0,6	12,80	6,65	0,15	3/4
5,0	1/4-28UNF	1/8	0,6	14,00	7,88	0,19	7/8
5,0	1/4-28UNF	1/8	0,6	14,00	7,88	0,19	15/16
5,0	1/4-28UNF	1/8	0,6	14,00	7,88	0,18	1
6,0	5/16-24UNF	5/32	0,6	19,50	11,20	0,35	1 1/8
6,0	5/16-24UNF	5/32	0,6	19,50	11,20	0,31	1 3/16
6,0	5/16-24UNF	5/32	0,6	19,50	11,20	0,28	1 1/4
6,5	5/16-24UNF	5/32	1,1	25,70	15,20	0,51	1 3/8
6,5	5/16-24UNF	5/32	1,1	25,70	15,20	0,48	1 7/16
6,5	5/16-24UNF	5/32	1,1	29,60	18,20	0,68	1 1/2
6,5	5/16-24UNF	5/32	1,1	31,85	20,80	0,82	1 5/8
6,5	5/16-24UNF	5/32	1,1	31,85	20,80	0,76	1 11/16
6,5	5/16-24UNF	5/32	1,1	31,85	20,80	0,73	1 3/4
6,5	5/16-24UNF	5/32	1,1	35,10	23,20	0,85	1 7/8
6,5	5/16-24UNF	5/32	1,1	35,10	23,20	0,83	1 15/16
8,0	3/8-24UNF	3/16	1,1	43,55	29,20	1,18	2
8,0	3/8-24UNF	3/16	1,1	43,55	29,20	0,81	2 3/16
8,0	3/8-24UNF	3/16	1,1	52,50	32,80	1,30	2 1/4
8,0	3/8-24UNF	3/16	1,1	52,50	32,80	1,09	2 7/16

* Width across flats (hexagon socket)



→ Bearing insert - inch

with eccentric locking collar

EX200

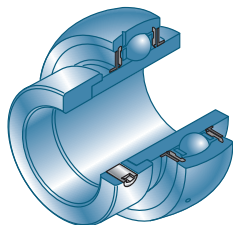

Shaft diameter		Bearing insert		Main dimensions [mm]					
d inch		D	C	B1	J2	B	s _{max}	D2	H1
1/2	EX201-08G2	47	16	34,0	13,5	43,5	17,0	32,4	4,4
5/8	EX202-10G2	47	16	34,0	13,5	43,5	17,0	32,4	4,4
11/16	EX203-11G2	47	16	34,0	13,5	43,5	17,0	32,4	4,4
3/4	EX204-12G2	47	16	34,0	13,5	43,5	17,0	32,4	4,4
7/8	EX205-14G2	52	17	34,8	13,5	44,3	17,4	37,4	4,3
15/16	EX205-15G2	52	17	34,8	13,5	44,3	17,4	37,4	4,3
1	EX205-16G2	52	17	34,8	13,5	44,3	17,4	37,4	4,3
1 1/8	EX206-18G2	62	19	36,4	15,9	48,3	18,2	44,1	5,0
1 3/16	EX206-19G2	62	19	36,4	15,9	48,3	18,2	44,1	5,0
1 1/4	EX206-20G2	62	19	36,4	15,9	48,3	18,2	44,1	5,0
1 3/8	EX207-22G2	72	20	37,6	17,5	51,1	18,8	51,1	5,8
1 7/16	EX207-23G2	72	20	37,6	17,5	51,1	18,8	51,1	5,8
1 1/2	EX208-24G2	80	21	42,8	18,3	56,3	21,4	58,0	6,3
1 5/8	EX209-26G2	85	22	42,8	18,3	56,3	21,4	63,5	6,8
1 11/16	EX209-27G2	85	22	42,8	18,3	56,3	21,4	63,5	6,8
1 3/4	EX209-28G2	85	22	42,8	18,3	56,3	21,4	63,5	6,8
1 7/8	EX210-30G2	90	23	49,2	18,3	62,7	24,6	67,2	6,5
1 15/16	EX210-31G2	90	23	49,2	18,3	62,7	24,6	67,2	6,5
2	EX211-32G2	100	25	55,4	20,7	71,3	27,7	74,5	7,2
2 3/16	EX211-35G2	100	25	55,4	20,7	71,3	27,7	74,5	7,2
2 1/4	EX212-36G2	110	27	61,8	22,3	77,7	30,9	82,0	8,2
2 7/16	EX212-39G2	110	27	61,8	22,3	77,7	30,9	82,0	8,2
2 1/2	EX213-40G2	120	28	68,2	23,5	85,7	34,1	86,0	8,0
2 11/16	EX214-43G2	125	30	68,2	23,5	85,7	34,1	96,8	9,0
2 3/4	EX214-44G2	125	30	68,2	23,5	85,7	34,1	96,8	9,0
2 15/16	EX215-47G2	130	30	74,6	23,9	92,1	37,3	102,0	9,0
3	EX215-48G2	130	30	74,6	23,9	92,1	37,3	102,0	9,0
3 1/4	EX217-52G2	150	35	53,2	27,0	73,2	23,4	119,0	11,0
3 1/2	EX218-56G2	160	37	55,0	24,0	72,5	24,5	120,0	10,3

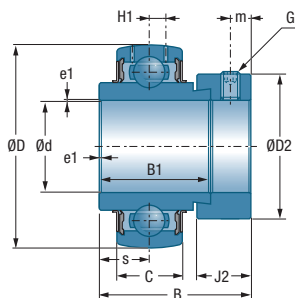

Main dimensions [mm]				Dynamic load rating	Static load rating	Weight	Shaft diameter
m	G	a* inch	e1	C _r [kN]	C _{0r} [kN]	kg	d inch
5,0	1/4-28UNF	1/8	0,6	12,80	6,65	0,29	1/2
5,0	1/4-28UNF	1/8	0,6	12,80	6,65	0,27	5/8
5,0	1/4-28UNF	1/8	0,6	12,80	6,65	0,24	11/16
5,0	1/4-28UNF	1/8	0,6	12,80	6,65	0,22	3/4
5,0	1/4-28UNF	1/8	0,6	14,00	7,88	0,25	7/8
5,0	1/4-28UNF	1/8	0,6	14,00	7,88	0,25	15/16
5,0	1/4-28UNF	1/8	0,6	14,00	7,88	0,24	1
6,0	5/16-24UNF	5/32	0,6	19,50	11,20	0,43	1 1/8
6,0	5/16-24UNF	5/32	0,6	19,50	11,20	0,40	1 3/16
6,0	5/16-24UNF	5/32	0,6	19,50	11,20	0,38	1 1/4
6,5	5/16-24UNF	5/32	1,1	25,70	15,20	0,61	1 3/8
6,5	5/16-24UNF	5/32	1,1	25,70	15,20	0,58	1 7/16
6,5	5/16-24UNF	5/32	1,1	29,60	18,20	0,83	1 1/2
6,5	5/16-24UNF	5/32	1,1	31,85	20,80	0,96	1 5/8
6,5	5/16-24UNF	5/32	1,1	31,85	20,80	0,91	1 11/16
6,5	5/16-24UNF	5/32	1,1	31,85	20,80	0,87	1 3/4
6,5	5/16-24UNF	5/32	1,1	35,10	23,20	1,10	1 7/8
6,5	5/16-24UNF	5/32	1,1	35,10	23,20	1,04	1 15/16
8,0	3/8-24UNF	3/16	1,5	43,55	29,20	1,58	2
8,0	3/8-24UNF	3/16	1,5	43,55	29,20	1,36	2 3/16
8,0	3/8-24UNF	3/16	1,5	52,50	32,80	2,03	2 1/4
8,0	3/8-24UNF	3/16	1,5	52,50	32,80	1,76	2 7/16
8,5	3/8-24UNF	3/16	1,5	57,20	40,00	2,51	2 1/2
8,5	3/8-24UNF	3/16	2,0	62,00	45,00	2,62	2 11/16
8,5	3/8-24UNF	3/16	2,0	62,00	45,00	2,58	2 3/4
8,5	3/8-24UNF	3/16	2,0	66,00	49,50	2,80	2 15/16
8,5	3/8-24UNF	3/16	2,0	66,00	49,50	2,74	3
10,0	7/16-20UNF	7/32	2,0	83,20	63,80	3,65	3 1/4
9,5	7/16-20UNF	7/32	2,0	96,00	71,50	5,00	3 1/2

* Width across flats (hexagon socket)



→ Bearing insert - inch

with adapter sleeve

UK200H

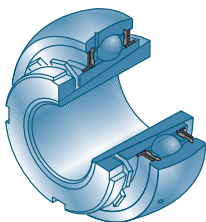

Shaft diameter inch	Bearing insert + adapter sleeve	Main dimensions [mm]							
		D	C	B1	c	B	d1	D1	D2
3/4	UK205G2H-12	52	17	21	8,0	35	25	34,0	38
7/8	UK206G2H-14	62	19	25	8,0	38	30	40,3	45
15/16	UK206G2H-15	62	19	25	8,0	38	30	40,3	45
1	UK206G2H-16	62	19	25	8,0	38	30	40,3	45
1 1/8	UK207G2H-18	72	20	27	9,0	43	35	48,0	52
1 3/16	UK207G2H-19	72	20	27	9,0	43	35	48,0	52
1 1/4	UK208G2H-20	80	21	29	10,0	46	40	53,0	58
1 3/8	UK208G2H-22	80	21	29	10,0	46	40	53,0	58
1 7/16	UK209G2H-23	85	22	30	11,0	50	45	57,2	65
1 1/2	UK209G2H-24	85	22	30	11,0	50	45	57,2	65
1 5/8	UK210G2H-26	90	23	31	12,0	55	50	61,8	70
1 11/16	UK210G2H-27	90	23	31	12,0	55	50	61,8	70
1 3/4	UK210G2H-28	90	23	31	12,0	55	50	61,8	70
1 7/8	UK211G2H-30	100	25	33	12,5	59	55	69,0	75
1 15/16	UK211G2H-31	100	25	33	12,5	59	55	69,0	75
2	UK211G2H-32	100	25	33	12,5	59	55	69,0	75
2 3/16	UK213G2H-35	120	28	36	14,0	65	65	82,0	85
2 1/4	UK213G2H-36	120	28	36	14,0	65	65	82,0	85
2 7/16	UK215G2H-39	130	30	41	15,0	73	75	91,5	98
2 1/2	UK215G2H-40	130	30	41	15,0	73	75	91,5	98
2 11/16	UK216G2H-43	140	33	44	17,0	78	80	98,0	105
2 3/4	UK216G2H-44	140	33	44	17,0	78	80	98,0	105
2 15/16	UK217G2H-47	150	35	44	18,0	82	85	105,1	110
3	UK217G2H-48	150	35	44	18,0	82	85	105,1	110

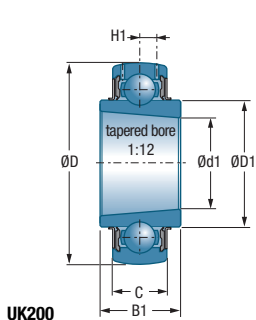

UK200

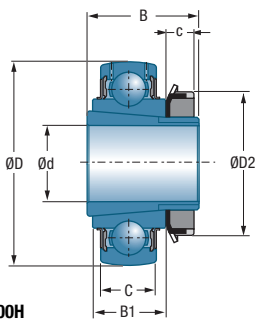

UK200H

H1	Bearing insert	Adapter sleeve	Dynamic load rating C_r [kN]	Static load rating C_{0r} [kN]	Weight, total Bearing insert + adapter sleeve kg	Weight Bearing insert kg	Shaft diameter inch
4,3	UK205G2	H2305-12	14,00	7,88	0,24	0,15	3/4
5,0	UK206G2	H2306-14	19,50	11,20	0,40	0,25	7/8
5,0	UK206G2	H2306-15	19,50	11,20	0,39	0,25	15/16
5,0	UK206G2	H2306-16	19,50	11,20	0,36	0,25	1
5,8	UK207G2	H2307-18	25,70	15,20	0,55	0,37	1 1/8
5,8	UK207G2	H2307-19	25,70	15,20	0,53	0,37	1 3/16
6,3	UK208G2	H2308-20	29,60	18,20	0,76	0,48	1 1/4
6,3	UK208G2	H2308-22	29,60	18,20	0,74	0,48	1 3/8
6,8	UK209G2	H2309-23	31,85	20,80	0,80	0,53	1 7/16
6,8	UK209G2	H2309-24	31,85	20,80	0,84	0,53	1 1/2
6,5	UK210G2	H2310-26	35,10	23,20	1,00	0,59	1 5/8
6,5	UK210G2	H2310-27	35,10	23,20	0,99	0,59	1 11/16
6,5	UK210G2	H2310-28	35,10	23,20	0,95	0,59	1 3/4
7,2	UK211G2	H2311-30	43,55	29,20	1,20	0,77	1 7/8
7,2	UK211G2	H2311-31	43,55	29,20	1,19	0,77	1 15/16
7,2	UK211G2	H2311-32	43,55	29,20	1,13	0,77	2
8,0	UK213G2	H2313-35	57,20	40,00	2,11	1,36	2 3/16
8,0	UK213G2	H2313-36	57,20	40,00	2,01	1,36	2 1/4
9,0	UK215G2	H2315-39	66,00	49,50	2,82	1,67	2 7/16
9,0	UK215G2	H2315-40	66,00	49,50	2,81	1,67	2 1/2
10,3	UK216G2	H2316-43	72,50	54,20	3,26	1,96	2 11/16
10,3	UK216G2	H2316-44	72,50	54,20	3,16	1,96	2 3/4
11,0	UK217G2	H2317-47	83,20	63,80	3,82	2,42	2 15/16
11,0	UK217G2	H2317-48	83,20	63,80	3,72	2,42	3

For the size of the appropriate hook spanner refer on page 22 in our ball bearing catalogue (TC09).

→ Bearing insert - inch

with set screws

UC300

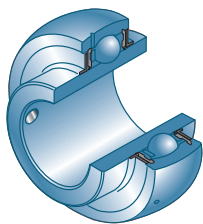

Shaft diameter		Bearing insert		Main dimensions [mm]			
d inch		D	C	B1	s _{max}	D1	H1
7/8	UC305-14G2	62	21	38	15	35,4	6,2
15/16	UC305-15G2	62	21	38	15	35,4	6,2
1	UC305-16G2	62	21	38	15	35,4	6,2
1 1/8	UC306-18G2	72	24	43	17	44,6	6,5
1 3/16	UC306-19G2	72	24	43	17	44,6	6,5
1 1/4	UC307-20G2	80	25	48	19	48,9	7,2
1 3/8	UC307-22G2	80	25	48	19	48,9	7,2
1 7/16	UC307-23G2	80	25	48	19	48,9	7,2
1 1/2	UC308-24G2	90	28	52	19	56,5	8,5
1 5/8	UC309-26G2	100	30	57	22	61,8	9,0
1 11/16	UC309-27G2	100	30	57	22	61,8	9,0
1 3/4	UC309-28G2	100	30	57	22	61,8	9,0
1 7/8	UC310-30G2	110	32	61	22	68,7	9,9
1 15/16	UC310-31G2	110	32	61	22	68,7	9,9
2	UC311-32G2	120	34	66	25	74,9	10,6
2 3/16	UC311-35G2	120	34	66	25	74,9	10,6
2 1/4	UC312-36G2	130	36	71	26	81,0	11,3
2 7/16	UC312-39G2	130	36	71	26	81,0	11,3
2 1/2	UC313-40G2	140	38	75	30	87,5	12,1
2 11/16	UC314-43G2	150	40	78	33	94,0	12,8
2 3/4	UC314-44G2	150	40	78	33	94,0	12,8
2 15/16	UC315-47G2	160	42	82	32	100,5	13,5
3	UC315-48G2	160	42	82	32	100,5	13,5
3 1/4	UC317-52G2	180	46	96	40	114,0	15,5
3 1/2	UC318-56G2	190	48	96	40	120,0	16,5
3 15/16	UC320-63G2	215	54	108	42	134,5	19,0

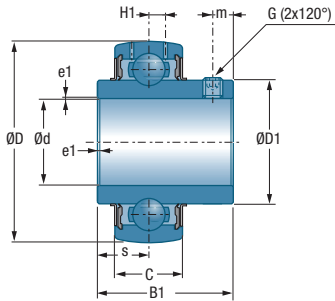

Main dimensions [mm]

Main dimensions [mm]				Dynamic load rating	Static load rating	Weight	Shaft diameter
m	G	a* inch	e1	C _r [kN]	C _{0r} [kN]	kg	d inch
6	1/4-28UNF	1/8	1,5	22,36	11,50	0,35	7/8
6	1/4-28UNF	1/8	1,5	22,36	11,50	0,35	15/16
6	1/4-28UNF	1/8	1,5	22,36	11,50	0,34	1
6	1/4-28UNF	1/8	1,5	27,00	15,20	0,58	1 1/8
6	1/4-28UNF	1/8	1,5	27,00	15,20	0,56	1 3/16
8	5/16-24UNF	5/32	2,0	33,50	19,20	0,77	1 1/4
8	5/16-24UNF	5/32	2,0	33,50	19,20	0,71	1 3/8
8	5/16-24UNF	5/32	2,0	33,50	19,20	0,70	1 7/16
10	3/8-24UNF	3/16	2,0	40,56	24,00	1,00	1 1/2
10	3/8-24UNF	3/16	2,0	53,00	31,80	1,36	1 5/8
10	3/8-24UNF	3/16	2,0	53,00	31,80	1,33	1 11/16
10	3/8-24UNF	3/16	2,0	53,00	31,80	1,30	1 3/4
12	7/16-20UNF	7/32	2,0	62,00	37,80	1,74	1 7/8
12	7/16-20UNF	7/32	2,0	62,00	37,80	1,68	1 15/16
12	7/16-20UNF	7/32	2,0	71,50	44,80	2,08	2
12	7/16-20UNF	7/32	2,0	71,50	44,80	1,87	2 3/16
12	7/16-20UNF	7/32	2,0	81,60	51,80	2,65	2 1/4
12	7/16-20UNF	7/32	2,0	81,60	51,80	2,50	2 7/16
12	7/16-20UNF	7/32	2,0	93,86	60,50	3,30	2 1/2
12	7/16-20UNF	7/32	2,5	104,26	68,00	4,00	2 11/16
12	7/16-20UNF	7/32	2,5	104,26	68,00	3,96	2 3/4
14	1/2-20UNF	1/4	2,5	113,36	76,80	4,29	2 15/16
14	1/2-20UNF	1/4	2,5	113,36	76,80	4,24	3
16	5/8-18UNF	5/16	3,0	132,60	96,50	6,76	3 1/4
16	5/8-18UNF	5/16	3,5	143,00	108,00	8,03	3 1/2
18	5/8-18UNF	5/16	3,5	171,60	140,00	11,00	3 15/16

* Width across flats (hexagon socket)



→ Bearing insert - inch

with eccentric locking collar

EX300

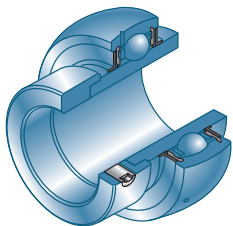

Shaft diameter		Bearing insert		Main dimensions [mm]						
d inch		D	C	B1	J2	B	s _{max}	D2	H1	
7/8	EX305-14G2	62	21	34,9	15,9	46,8	16,7	42,8	6,2	
15/16	EX305-15G2	62	21	34,9	15,9	46,8	16,7	42,8	6,2	
1	EX305-16G2	62	21	34,9	15,9	46,8	16,7	42,8	6,2	
1 1/8	EX306-18G2	72	24	36,5	17,5	50,0	17,5	50,0	6,5	
1 3/16	EX306-19G2	72	24	36,5	17,5	50,0	17,5	50,0	6,5	
1 1/4	EX307-20G2	80	25	38,1	17,5	51,6	18,3	55,0	7,2	
1 3/8	EX307-22G2	80	25	38,1	17,5	51,6	18,3	55,0	7,2	
1 7/16	EX307-23G2	80	25	38,1	17,5	51,6	18,3	55,0	7,2	
1 1/2	EX308-24G2	90	28	41,3	20,6	57,1	19,8	63,5	8,5	
1 5/8	EX309-26G2	100	30	42,9	20,6	58,7	19,8	70,0	9,0	
1 11/16	EX309-27G2	100	30	42,9	20,6	58,7	19,8	70,0	9,0	
1 3/4	EX309-28G2	100	30	42,9	20,6	58,7	19,8	70,0	9,0	
1 7/8	EX310-30G2	110	32	49,2	22,2	66,6	24,6	76,2	9,9	
1 15/16	EX310-31G2	110	32	49,2	22,2	66,6	24,6	76,2	9,9	
2	EX311-32G2	120	34	55,6	22,2	73,0	27,8	83,0	10,6	
2 3/16	EX311-35G2	120	34	55,6	22,2	73,0	27,8	83,0	10,6	
2 1/4	EX312-36G2	130	36	61,9	23,9	79,4	31,0	89,0	11,3	
2 7/16	EX312-39G2	130	36	61,9	23,9	79,4	31,0	89,0	11,3	
2 1/2	EX313-40G2	140	38	65,1	27,0	85,7	32,5	97,0	12,1	
2 11/16	EX314-43G2	150	40	68,3	30,2	92,1	34,2	102,0	12,8	
2 3/4	EX314-44G2	150	40	68,3	30,2	92,1	34,2	102,0	12,8	
2 15/16	EX315-47G2	160	42	74,6	31,8	100,0	37,3	113,0	13,5	
3	EX315-48G2	160	42	74,6	31,8	100,0	37,3	113,0	13,5	
3 1/4	EX317-52G2	180	46	84,1	31,8	109,5	42,0	127,0	15,5	
3 1/2	EX318-56G2	190	48	87,3	36,5	87,3	43,6	133,0	16,5	
3 15/16	EX320-63G2	215	54	100,0	36,5	128,6	50,0	146,0	19,0	

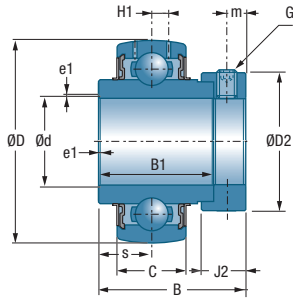

Main dimensions [mm]

Main dimensions [mm]				Dynamic load rating	Static load rating	Weight	Shaft diameter
m	G	a* inch	e1	C _r [kN]	C _{0r} [kN]	kg	d inch
6,0	5/16-24UNF	5/32	1,5	22,36	11,50	0,43	7/8
6,0	5/16-24UNF	5/32	1,5	22,36	11,50	0,43	15/16
6,0	5/16-24UNF	5/32	1,5	22,36	11,50	0,43	1
6,7	5/16-24UNF	5/32	1,5	27,00	15,20	0,71	1 1/8
6,7	5/16-24UNF	5/32	1,5	27,00	15,20	0,68	1 3/16
6,7	5/16-24UNF	5/32	2,0	33,50	19,20	0,86	1 1/4
6,7	5/16-24UNF	5/32	2,0	33,50	19,20	0,80	1 3/8
6,7	5/16-24UNF	5/32	2,0	33,50	19,20	0,78	1 7/16
8,0	3/8-24UNF	3/16	2,0	40,56	24,00	1,13	1 1/2
8,0	3/8-24UNF	3/16	2,0	53,00	31,80	1,57	1 5/8
8,0	3/8-24UNF	3/16	2,0	53,00	31,80	1,52	1 11/16
8,0	3/8-24UNF	3/16	2,0	53,00	31,80	1,47	1 3/4
8,7	3/8-24UNF	3/16	2,0	62,00	37,80	1,93	1 7/8
8,7	3/8-24UNF	3/16	2,0	62,00	37,80	1,88	1 15/16
9,0	3/8-24UNF	3/16	2,0	71,50	44,80	2,49	2
9,0	3/8-24UNF	3/16	2,0	71,50	44,80	2,24	2 3/16
9,0	3/8-24UNF	3/16	2,0	81,60	51,80	2,95	2 1/4
9,0	3/8-24UNF	3/16	2,0	81,60	51,80	2,86	2 7/16
11,5	7/16-20UNF	7/32	2,0	93,86	60,50	3,85	2 1/2
12,0	7/16-20UNF	7/32	2,5	104,26	68,00	4,45	2 11/16
12,0	7/16-20UNF	7/32	2,5	104,26	68,00	4,40	2 3/4
13,0	5/8-18UNF	5/16	2,5	113,36	76,80	5,40	2 15/16
13,0	5/8-18UNF	5/16	2,5	113,36	76,80	5,28	3
14,0	5/8-18UNF	5/16	3,0	132,60	96,50	7,88	3 1/4
15,0	3/4-16UNF	3/8	3,0	143,00	108,00	9,20	3 1/2
16,0	3/4-16UNF	3/8	3,5	171,60	140,00	12,85	3 15/16

* Width across flats (hexagon socket)



→ Bearing insert - inch

with adapter sleeve

UK300H

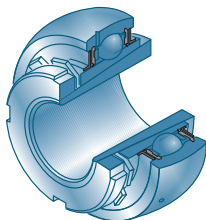

Shaft diameter	Bearing insert + adapter sleeve	Main dimensions [mm]							
		d inch	D	C	B1	c	B	d1	D1
3/4	UK305G2H-12	62	21	27	8,0	35	25	35,4	38
7/8	UK306G2H-14	72	24	30	8,0	38	30	44,6	45
15/16	UK306G2H-15	72	24	30	8,0	38	30	44,6	45
1	UK306G2H-16	72	24	30	8,0	38	30	44,6	45
1 1/8	UK307G2H-18	80	25	33	9,0	43	35	48,9	52
1 3/16	UK307G2H-19	80	25	33	9,0	43	35	48,9	52
1 1/4	UK308G2H-20	90	28	35	10,0	46	40	56,5	58
1 3/8	UK308G2H-22	90	28	35	10,0	46	40	56,5	58
1 7/16	UK309G2H-23	100	30	38	11,0	50	45	61,8	65
1 1/2	UK309G2H-24	100	30	38	11,0	50	45	61,8	65
1 5/8	UK310G2H-26	110	32	40	12,0	55	50	68,7	70
1 11/16	UK310G2H-27	110	32	40	12,0	55	50	68,7	70
1 3/4	UK310G2H-28	110	32	40	12,0	55	50	68,7	70
1 7/8	UK311G2H-30	120	34	43	12,5	59	55	74,9	75
1 15/16	UK311G2H-31	120	34	43	12,5	59	55	74,9	75
2	UK311G2H-32	120	34	43	12,5	59	55	74,9	75
2 3/16	UK313G2H-35	140	38	49	14,0	65	65	87,5	85
2 1/4	UK313G2H-36	140	38	49	14,0	65	65	87,5	85
2 7/16	UK315G2H-39	160	42	55	15,0	73	75	100,5	98
2 1/2	UK315G2H-40	160	42	55	15,0	73	75	100,5	98
2 11/16	UK316G2H-43	170	44	55	17,0	78	80	107,9	105
2 3/4	UK316G2H-44	170	44	55	17,0	78	80	107,9	105
2 15/16	UK317G2H-47	180	46	60	18,0	82	85	114,0	110
3	UK317G2H-48	180	46	60	18,0	82	85	114,0	110
3 1/4	UK319G2H-55	200	50	66	19,0	90	95	126,5	125
3 1/2	UK320G2H-56	215	54	68	20,0	97	100	134,5	130

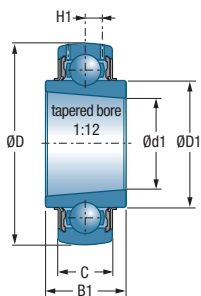

UK300

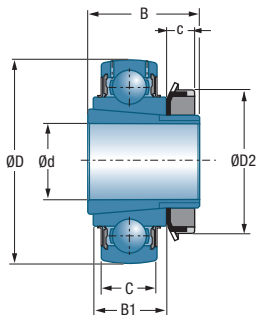

UK300H

H1	Bearing insert	Adapter sleeve	Dynamic load rating	Static load rating	Total weight Bearing insert + adapter sleeve	Bearing insert Weight	Shaft diameter
H1			C_r [kN]	C_{Or} [kN]	kg	kg	d inch
6,2	UK305G2	H2305-12	22,36	11,50	0,49	0,40	3/4
6,5	UK306G2	H2306-14	27,00	15,20	0,61	0,46	7/8
6,5	UK306G2	H2306-15	27,00	15,20	0,60	0,46	15/16
6,5	UK306G2	H2306-16	27,00	15,20	0,57	0,46	1
7,2	UK307G2	H2307-18	33,50	19,20	0,93	0,75	1 1/8
7,2	UK307G2	H2307-19	33,50	19,20	0,91	0,75	1 3/16
8,5	UK308G2	H2308-20	40,56	24,00	1,09	0,81	1 1/4
8,5	UK308G2	H2308-22	40,56	24,00	1,09	0,81	1 3/8
9,0	UK309G2	H2309-23	53,00	31,80	1,46	1,19	1 7/16
9,0	UK309G2	H2309-24	53,00	31,80	1,50	1,19	1 1/2
9,9	UK310G2	H2310-26	62,00	37,80	1,68	1,38	1 5/8
9,9	UK310G2	H2310-27	62,00	37,80	1,78	1,38	1 11/16
9,9	UK310G2	H2310-28	62,00	37,80	1,74	1,38	1 3/4
10,6	UK311G2	H2311-30	71,50	44,80	2,21	1,78	1 7/8
10,6	UK311G2	H2311-31	71,50	44,80	2,20	1,78	1 15/16
10,6	UK311G2	H2311-32	71,50	44,80	2,14	1,78	2
12,1	UK313G2	H2313-35	93,86	60,50	3,46	2,71	2 3/16
12,1	UK313G2	H2313-36	93,86	60,50	3,36	2,71	2 1/4
13,5	UK315G2	H2315-39	113,36	76,80	5,13	3,98	2 7/16
13,5	UK315G2	H2315-40	113,36	76,80	5,10	3,98	2 1/2
14,5	UK316G2	H2316-43	122,85	86,50	5,85	4,55	2 11/16
14,5	UK316G2	H2316-44	122,85	86,50	5,75	4,55	2 3/4
15,5	UK317G2	H2317-47	132,60	96,50	6,84	5,44	2 15/16
15,5	UK317G2	H2317-48	132,60	96,50	6,74	5,44	3
16,7	UK319G2	H2319-55	156,00	122,00	9,66	7,31	3 1/4
19,0	UK320G2	H2320-56	171,60	140,00	10,62	8,82	3 1/2

For the size of the appropriate hook spanner refer on page 22 in our ball bearing catalogue (TC09).



→ Bearing insert - inch

with cylindrical outer ring and set screws

CUC200

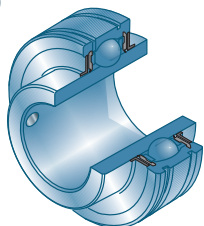

		Main dimensions [mm]							
Shaft diameter	Bearing insert	D	C	B1	s _{max}	D1	H1	m	N
d inch									
3/4	CUC204-12	47	17	31,0	12,7	29,0	4,0	4,5	1,35
7/8	CUC205-14	52	17	34,0	14,3	34,0	4,1	5,0	1,35
15/16	CUC205-15	52	17	34,0	14,3	34,0	4,1	5,0	1,35
1	CUC205-16	52	17	34,0	14,3	34,0	4,1	5,0	1,35
1 1/8	CUC206-18	62	19	38,1	15,9	40,3	4,2	5,5	1,90
1 3/16	CUC206-19	62	19	38,1	15,9	40,3	4,2	5,5	1,90
1 1/4	CUC206-20	62	19	38,1	15,9	40,3	4,2	5,5	1,90
1 3/8	CUC207-22	72	20	42,9	17,5	46,9	5,0	6,5	1,90
1 7/16	CUC207-23	72	20	42,9	17,5	46,9	5,0	6,5	1,90
1 1/2	CUC208-24	80	21	49,2	19,0	53,0	5,0	8,0	1,90
1 5/8	CUC209-26	85	22	49,2	19,0	57,2	5,1	8,0	1,90
1 11/16	CUC209-27	85	22	49,2	19,0	57,2	5,1	8,0	1,90
1 3/4	CUC209-28	85	22	49,2	19,0	57,2	5,1	8,0	1,90
1 7/8	CUC210-30	90	23	51,6	19,0	61,8	5,6	9,0	2,70
1 15/16	CUC210-31	90	23	51,6	19,0	61,8	5,6	9,0	2,70

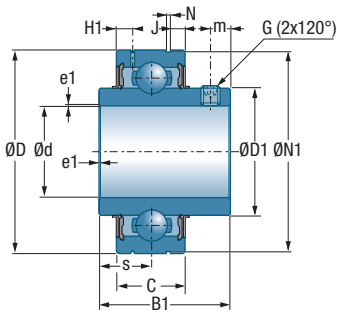

Main dimensions [mm]

Main dimensions [mm]					Dynamic load rating	Static load rating	Weight	Shaft diameter
J	N1	G	a* inch	e1	C _r [kN]	C _{0r} [kN]	kg	d inch
3,1	44,60	1/4-28UNF	1/8	0,6	12,80	6,65	0,20	3/4
3,2	49,73	1/4-28UNF	1/8	0,6	14,00	7,88	0,21	7/8
3,2	49,73	1/4-28UNF	1/8	0,6	14,00	7,88	0,21	15/16
3,2	49,73	1/4-28UNF	1/8	0,6	14,00	7,88	0,21	1
3,2	59,61	1/4-28UNF	1/8	0,6	19,50	11,20	0,34	1 1/8
3,2	59,61	1/4-28UNF	1/8	0,6	19,50	11,20	0,31	1 3/16
3,2	59,61	1/4-28UNF	1/8	0,6	19,50	11,20	0,30	1 1/4
3,3	68,81	5/16-24UNF	5/32	1,1	25,70	15,20	0,48	1 3/8
3,3	68,81	5/16-24UNF	5/32	1,1	25,70	15,20	0,45	1 7/16
3,4	76,81	5/16-24UNF	5/32	1,1	29,60	18,20	0,68	1 1/2
3,5	81,81	5/16-24UNF	5/32	1,1	31,85	20,80	0,78	1 5/8
3,5	81,81	5/16-24UNF	5/32	1,1	31,85	20,80	0,74	1 11/16
3,5	81,81	5/16-24UNF	5/32	1,1	31,85	20,80	0,70	1 3/4
3,7	86,79	3/8-24UNF	3/16	1,1	35,10	23,20	0,80	1 7/8
3,7	86,79	3/8-24UNF	3/16	1,1	35,10	23,20	0,82	1 15/16

* Width across flats (hexagon socket)



→ Bearing insert - inch

with cylindrical outer ring and set screws

CUS200

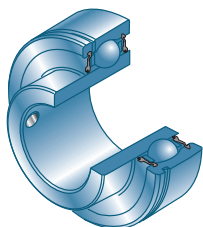

		Main dimensions [mm]							
Shaft diameter	Bearing insert	D	C	B1	s _{max}	D1	m	N	J
d inch									
3/4	CUS204-12	47	14	25,0	7,0	28,3	5	1,35	2,38
7/8	CUS205-14	52	15	27,0	7,5	34,0	5	1,35	2,38
15/16	CUS205-15	52	15	27,0	7,5	34,0	5	1,35	2,38
1	CUS205-16	52	15	27,0	7,5	34,0	5	1,35	2,38
1 1/8	CUS206-18	62	16	30,0	8,0	40,0	5,5	1,90	3,18
1 3/16	CUS206-19	62	16	30,0	8,0	40,0	5,5	1,90	3,18
1 1/4	CUS206-20	62	16	30,0	8,0	40,0	5,5	1,90	3,18
1 3/8	CUS207-22	72	17	32,0	8,5	46,9	6	1,90	3,18
1 7/16	CUS207-23	72	17	32,0	8,5	46,9	6	1,90	3,18
1 1/2	CUS208-24	80	18	34,0	9,0	52,4	8	1,90	3,18
1 5/8	CUS209-26	85	19	41,2	9,5	57,6	8	1,90	3,18
1 11/16	CUS209-27	85	19	41,2	9,5	57,6	8	1,90	3,18
1 3/4	CUS209-28	85	19	41,2	9,5	57,6	8	1,90	3,18
1 7/8	CUS210-30	90	20	43,5	10,0	63,2	9	2,70	3,70
1 15/16	CUS210-31	90	20	43,5	10,0	63,2	9	2,70	3,70

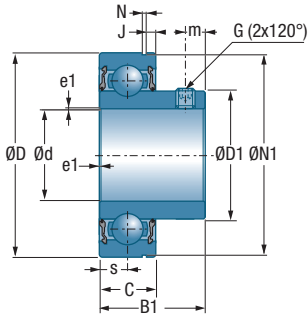

Main dimensions [mm]

Main dimensions [mm]				Dynamic load rating	Static load rating	Weight	Shaft diameter
N1	G	a* inch	e1	C _r [kN]	C _{0r} [kN]	kg	d inch
44,60	1/4-28UNF	1/8	1,0	12,80	6,65	0,13	3/4
49,73	1/4-28UNF	1/8	1,0	14,00	7,88	0,18	7/8
49,73	1/4-28UNF	1/8	1,0	14,00	7,88	0,18	15/16
49,73	1/4-28UNF	1/8	1,0	14,00	7,88	0,18	1
59,61	1/4-28UNF	1/8	1,0	19,50	11,20	0,28	1 1/8
59,61	1/4-28UNF	1/8	1,0	19,50	11,20	0,25	1 3/16
59,61	1/4-28UNF	1/8	1,0	19,50	11,20	0,24	1 1/4
68,81	1/4-28UNF	1/8	1,0	25,70	15,20	0,38	1 3/8
68,81	1/4-28UNF	1/8	1,0	25,70	15,20	0,37	1 7/16
76,81	5/16-24UNF	5/32	1,0	29,60	18,20	0,60	1 1/2
81,81	5/16-24UNF	5/32	1,5	31,85	20,80	0,75	1 5/8
81,81	5/16-24UNF	5/32	1,5	31,85	20,80	0,72	1 11/16
81,81	5/16-24UNF	5/32	1,5	31,85	20,80	0,67	1 3/4
86,79	5/16-24UNF	5/32	1,5	35,10	23,20	0,80	1 7/8
86,79	5/16-24UNF	5/32	1,5	35,10	23,20	0,78	1 15/16

* Width across flats (hexagon socket)



→ Bearing insert - inch

with cylindrical outer ring and eccentric locking collar

CES200

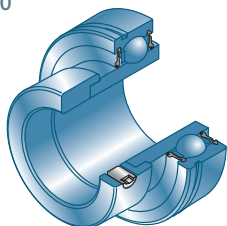

d inch	Bearing insert	Main dimensions [mm]								
		D	C	B1	J2	B	s _{max}	D2	m	N
3/4	CES204-12	47	14	21,5	13,5	31,0	7,0	33,3	5,0	1,35
7/8	CES205-14	52	15	21,5	13,5	31,0	7,5	38,1	5,0	1,35
15/16	CES205-15	52	15	21,5	13,5	31,0	7,5	38,1	5,0	1,35
1	CES205-16	52	15	21,5	13,5	31,0	7,5	38,1	5,0	1,35
1 1/8	CES206-18	62	16	23,8	15,9	35,7	8,0	44,5	6,0	1,90
1 3/16	CES206-19	62	16	23,8	15,9	35,7	8,0	44,5	6,0	1,90
1 1/4	CES206-20	62	16	23,8	15,9	35,7	8,0	44,5	6,0	1,90
1 3/8	CES207-22	72	17	25,4	17,5	38,9	8,5	55,6	6,5	1,90
1 7/16	CES207-23	72	17	25,4	17,5	38,9	8,5	55,6	6,5	1,90
1 1/2	CES208-24	80	18	30,2	18,3	43,7	9,0	60,3	6,5	1,90
1 5/8	CES209-26	85	19	30,2	18,3	43,7	9,5	63,5	6,5	1,90
1 11/16	CES209-27	85	19	30,2	18,3	43,7	9,5	63,5	6,5	1,90
1 3/4	CES209-28	85	19	30,2	18,3	43,7	9,5	63,5	6,5	1,90
1 7/8	CES210-30	90	20	30,2	18,3	43,7	10,0	69,9	6,5	2,70
1 15/16	CES210-31	90	20	30,2	18,3	43,7	10,0	69,9	6,5	2,70

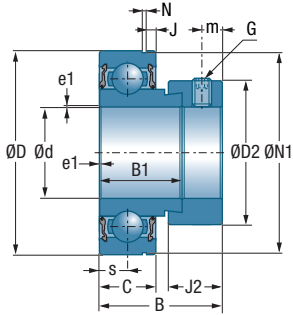

Main dimensions [mm]

Main dimensions [mm]					Dynamic load rating	Static load rating	Weight	Shaft diameter
J	N1	G	a* inch	e1	C _r [kN]	C _{0r} [kN]	kg	d inch
2,38	44,60	1/4-28UNF	1/8	1,0	12,80	6,65	0,15	3/4
2,38	49,73	1/4-28UNF	1/8	1,0	14,00	7,88	0,19	7/8
2,38	49,73	1/4-28UNF	1/8	1,0	14,00	7,88	0,19	15/16
2,38	49,73	1/4-28UNF	1/8	1,0	14,00	7,88	0,18	1
3,18	59,61	5/16-24UNF	5/32	1,0	19,50	11,20	0,35	1 1/8
3,18	59,61	5/16-24UNF	5/32	1,0	19,50	11,20	0,31	1 3/16
3,18	59,61	5/16-24UNF	5/32	1,0	19,50	11,20	0,28	1 1/4
3,18	68,81	5/16-24UNF	5/32	1,5	25,70	15,20	0,51	1 3/8
3,18	68,81	5/16-24UNF	5/32	1,5	25,70	15,20	0,48	1 7/16
3,18	76,81	5/16-24UNF	5/32	1,5	29,60	18,20	0,68	1 1/2
3,18	81,81	5/16-24UNF	5/32	1,5	31,85	20,80	0,82	1 5/8
3,18	81,81	5/16-24UNF	5/32	1,5	31,85	20,80	0,76	1 11/16
3,18	81,81	5/16-24UNF	5/32	1,5	31,85	20,80	0,73	1 3/4
3,70	86,79	5/16-24UNF	5/32	1,5	35,10	23,20	0,85	1 7/8
3,70	86,79	5/16-24UNF	5/32	1,5	35,10	23,20	0,83	1 15/16

* Width across flats (hexagon socket)



→ Bearing insert

with cylindrical outer ring and eccentric locking collar

CEX200

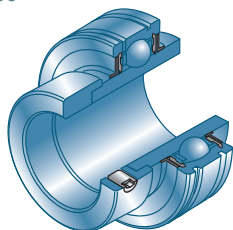

Shaft diameter		Bearing insert		Main dimensions [mm]						
d inch		D	C	B1	J2	B	s _{max}	D2	H1	m
3/4	CEX204-12	47	17	34,2	13,5	43,7	17,1	33,5	4,0	5,0
7/8	CEX205-14	52	17	34,9	13,5	44,4	17,5	38,1	4,1	5,0
15/16	CEX205-15	52	17	34,9	13,5	44,4	17,5	38,1	4,1	5,0
1	CEX205-16	52	17	34,9	13,5	44,4	17,5	38,1	4,1	5,0
1 1/8	CEX206-18	62	19	36,5	15,9	48,4	18,3	44,5	4,2	6,0
1 3/16	CEX206-19	62	19	36,5	15,9	48,4	18,3	44,5	4,2	6,0
1 1/4	CEX206-20	62	19	36,5	15,9	48,4	18,3	44,5	4,2	6,0
1 3/8	CEX207-22	72	20	37,6	17,5	51,1	18,8	55,5	5,0	6,5
1 7/16	CEX207-23	72	20	37,6	17,5	51,1	18,8	55,5	5,0	6,5
1 1/2	CEX208-24	80	21	42,8	18,3	56,3	21,4	60,3	5,0	6,5
1 5/8	CEX209-26	85	22	42,8	18,3	56,3	21,4	63,5	5,1	6,5
1 11/16	CEX209-27	85	22	42,8	18,3	56,3	21,4	63,5	5,1	6,5
1 3/4	CEX209-28	85	22	42,8	18,3	56,3	21,4	63,5	5,1	6,5
1 7/8	CEX210-30	90	24	49,2	18,3	62,7	24,6	69,5	5,6	6,5
1 15/16	CEX210-31	90	24	49,2	18,3	62,7	24,6	69,5	5,6	6,5

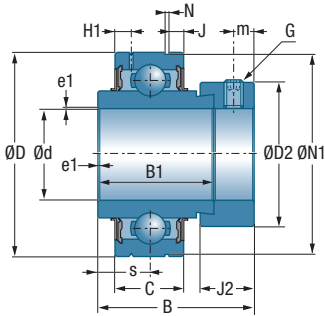

Main dimensions [mm]

Main dimensions [mm]						Dynamic load rating	Static load rating	Weight	Shaft diameter
N	J	N1	G	a* inch	e1	C _r [kN]	C _{0r} [kN]	kg	d inch
1,35	3,1	44,60	1/4-28UNF	1/8	1,0	12,80	6,65	0,22	3/4
1,35	3,2	49,73	1/4-28UNF	1/8	1,0	14,00	7,88	0,25	7
1,35	3,2	49,73	1/4-28UNF	1/8	1,0	14,00	7,88	0,25	15/16
1,35	3,2	49,73	1/4-28UNF	1/8	1,0	14,00	7,88	0,24	1
1,90	3,2	59,61	5/16-24UNF	5/32	1,0	19,50	11,20	0,43	1 1/8
1,90	3,2	59,61	5/16-24UNF	5/32	1,0	19,50	11,20	0,40	1 3/16
1,90	3,2	59,61	5/16-24UNF	5/32	1,0	19,50	11,20	0,38	1 1/4
1,90	3,3	68,81	5/16-24UNF	5/32	1,5	25,70	15,20	0,61	1 3/8
1,90	3,3	68,81	5/16-24UNF	5/32	1,5	25,70	15,20	0,58	1 7/16
1,90	3,4	76,81	5/16-24UNF	5/32	1,5	29,60	18,20	0,83	1 1/2
1,90	3,5	81,81	5/16-24UNF	5/32	1,5	31,85	20,80	0,96	1 5/8
1,90	3,5	81,81	5/16-24UNF	5/32	1,5	31,85	20,80	0,91	1 11/16
1,90	3,5	81,81	5/16-24UNF	5/32	1,5	31,85	20,80	0,87	1 3/4
3,70	3,7	86,79	5/16-24UNF	5/32	1,5	35,10	23,20	1,10	1 7/8
3,70	3,7	86,79	5/16-24UNF	5/32	1,5	35,10	23,20	1,04	1 15/16

* Width across flats (hexagon socket)



➔ Bearing insert with set-screws - SUC200

Standard design with 2 set screws
and lubrication holes in the outer ring

Shaft diameter	
metric	inch
12 - 60 mm	3/4 - 2 7/16

Shaft diameter		Bearing insert	Main dimensions [mm]			
			D	B1	s	e1
d mm	d inch					
12		SUC201	47	31	12,7	0,5
15		SUC202	47	31	12,7	0,5
17		SUC203	47	31	12,7	0,5
20		SUC204	47	31	12,7	0,5
	3/4	SUC204-12	47	31	12,7	0,5
25		SUC205	52	34,1	14,3	0,5
	1	SUC205-16	52	34,1	14,3	0,5
30		SUC206	62	38,1	15,9	0,5
	1 3/16	SUC206-19	62	38,1	15,9	0,5
	1 1/4	SUC206-20	62	38,1	15,9	0,5
35		SUC207	72	42,9	17,5	1
	1 3/8	SUC207-22	72	42,9	17,5	1
	1 7/16	SUC207-23	72	42,9	17,5	1
40		SUC208	80	49,2	19	1
	1 1/2	SUC208-24	80	49,2	19	1
45		SUC209	85	49,2	19	1
	1 3/4	SUC209-28	85	49,2	19	1
50		SUC210	90	51,6	19	1
	1 15/16	SUC210-31	90	51,6	19	1
	2	SUC211-32	100	55,6	22,2	1
55		SUC211	100	55,6	22,2	1
	2 3/16	SUC211-35	100	55,6	22,2	1
60		SUC212	110	65,1	25,4	1
	2 7/16	SUC212-39	110	65,1	25,4	1

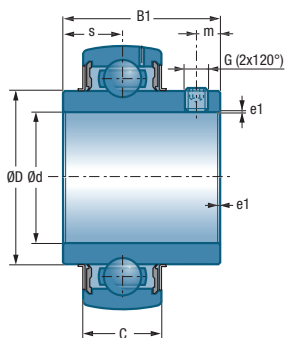

Main dimensions [mm]

Main dimensions [mm]			Bearing load rating (N)	Total weight	Shaft diameter		
C	G	m	C_r dyn.	C_{0r} stat.	kg	d inch	d mm
17	M6x1	5	10,10	6,80	0,21		12
17	M6x1	5	10,10	6,80	0,19		15
17	M6x1	5	10,10	6,80	0,18		17
17	M6x1	5	10,10	6,80	0,16		20
17	M6x1	5	10,10	6,80	0,16	3/4	
17	M6x1	5	11,00	8,00	0,20		25
17	M6x1	5	11,00	8,00	0,20	1	
19	M6x1	5	15,30	11,50	0,32		30
19	M6x1	5	15,30	11,50	0,32	1 3/16	
19	M6x1	5	15,30	11,50	0,32	1 1/4	
20	M8x1	6	20,10	15,60	0,47		35
20	M8x1	6	20,10	15,60	0,47	1 3/8	
20	M8x1	6	20,10	15,60	0,47	1 7/16	
21	M8x1	8	22,80	18,20	0,63		40
21	M8x1	8	22,80	18,20	0,63	1 1/2	
22	M10x1,25	8	25,70	20,80	0,69		45
22	M10x1,25	8	25,70	20,80	0,69	1 3/4	
24	M10x1,25	10	27,50	23,70	0,77		50
24	M10x1,25	10	27,50	23,70	0,77	1 15/16	
25	M10x1,25	10	34,00	25,50	1,06	2	
25	M10x1,25	10	34,00	25,50	1,06		55
25	M10x1,25	10	34,00	25,50	1,06	2 3/16	
27	M10x1,25	10	41,00	31,50	1,47		60
27	M10x1,25	10	41,00	31,50	1,47	2 7/16	



→ Bearing inserts with eccentric locking collar - SES200

Standard design with eccentric locking collar and lubrication holes in the outer ring

Shaft diameter	
metric	inch
12 - 60 mm	3/4 - 2

			Main dimensions [mm]				
d mm	d inch		D	B	s	e1	C
12		SES201	40	28,6	6	0,5	12
15		SES202	40	28,6	6	0,5	12
17		SES203	40	28,6	6	0,5	12
20		SES204	47	31	7	0,5	14
	3/4	SES204-12	47	31	7	0,5	14
25		SES205	52	31	7,5	0,5	15
	1	SES205-16	52	31	7,5	0,5	15
30		SES206	62	35,7	8	0,5	16
	1 3/16	SES206-19	62	35,7	8	0,5	16
	1 1/4	SES206-20	62	35,7	8	0,5	16
35		SES207	72	38,9	8,5	1	17
	1 3/8	SES207-22	72	38,9	8,5	1	17
	1 7/16	SES207-23	72	38,9	8,5	1	17
40		SES208	80	43,7	9	1	18
	1 1/2	SES208-24	80	43,7	9	1	18
45		SES209	85	43,7	9,5	1	19
	1 3/4	SES209-28	85	43,7	9,5	1	19
50		SES210	90	43,7	10	1	20
	1 15/16	SES210-31	90	43,7	10	1	20
	2	SES211-32	100	48,4	10,5	1	21
55		SES211	100	48,4	10,5	1	21
60		SES212	110	53,1	11	1	22

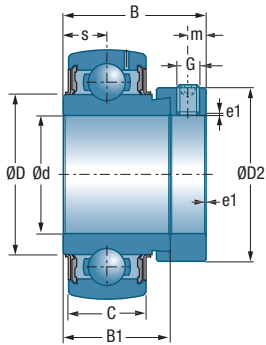

Main dimensions [mm]

Main dimensions [mm]				Bearing load rating (N)		Total weight		Shaft diameter	
G	m	B1	D2	C _r dyn.	C _{0r} stat.	kg	d inch	d mm	
M6x1	5	19,1	28,6	7,80	4,50	0,14		12	
M6x1	5	19,1	28,6	7,80	4,50	0,12		15	
M6x1	5	19,1	28,6	7,80	4,50	0,11		17	
M6x1	5	21,5	33,3	10,10	6,80	0,17		20	
M6x1	5	21,5	33,3	10,10	6,80	0,17	3/4		
M6x1	5	21,5	38,1	11,00	8,00	0,20		25	
M6x1	5	21,5	38,1	11,00	8,00	0,20	1		
M8x1	6	23,8	44,5	15,30	11,50	0,32		30	
M8x1	6	23,8	44,5	15,30	11,50	0,32	1 3/16		
M8x1	6	23,8	44,5	15,30	11,50	0,32	1 1/4		
M8x1	6,5	25,4	55,6	20,10	15,60	0,51		35	
M8x1	6,5	25,4	55,6	20,10	15,60	0,51	1 3/8		
M8x1	6,5	25,4	55,6	20,10	15,60	0,51	1 7/16		
M8x1	6,5	30,2	60,3	22,80	18,20	0,64		40	
M8x1	6,5	30,2	60,3	22,80	18,20	0,64	1 1/2		
M8x1	6,5	30,2	63,5	25,70	20,80	0,67		45	
M8x1	6,5	30,2	63,5	25,70	20,80	0,67	1 3/4		
M8x1	6,5	30,2	69,9	27,50	23,70	0,75		50	
M8x1	6,5	30,2	69,9	27,50	23,70	0,75	1 15/16		
M10x1,25	8	32,5	76,2	34,00	25,50	1,03	2		
M10x1,25	8	32,5	76,2	34,00	25,50	1,03		55	
M10x1,25	8	37,1	84,2	41,00	31,50	1,34		60	



Stainless steel bearing inserts

→ MUC (inch)

Unit	Main dimensions [mm]											
	Bore d		D		C		B1		s		D1	
Bearings	inch	mm	inch	mm	inch	mm	inch	mm	inch	mm	inch	mm
MUC 202-10 FD	5/8	15,875	1,850	47	0,669	17	1,220	31,00	0,500	12,7	1,142	29,0
MUC 204-12 FD	3/4	19,050	1,850	47	0,669	17	1,220	31,00	0,500	12,7	1,142	29,0
MUC 205-16 FD	1	25,400	2,047	52	0,669	17	1,339	34,10	0,563	14,3	1,339	34,0
MUC 206-18 FD	1-1/8	28,575	2,441	62	0,748	19	1,500	38,10	0,626	15,9	1,594	40,5
MUC 206-19 FD	1-3/16	30,162	2,441	62	0,748	19	1,500	38,10	0,626	15,9	1,594	40,5
MUC 206-20 FD	1-1/4	31,750	2,441	62	0,748	19	1,500	38,10	0,626	15,9	1,594	40,5
MUC 207-20 FD	1-1/4	31,750	2,835	72	0,787	20	1,689	42,90	0,689	17,5	1,890	48,0
MUC 207-22 FD	1-3/8	34,925	2,835	72	0,787	20	1,689	42,90	0,689	17,5	1,890	48,0
MUC 207-23 FD	1-7/16	36,512	2,835	72	0,787	20	1,689	42,90	0,689	17,5	1,890	48,0
MUC 208-24 FD	1-1/2	38,100	3,150	80	0,827	21	1,937	49,20	0,748	19,0	2,087	53,0

→ MUC (metric)

Unit	Main dimensions [mm]					
	Bore d	D	C	B1	s	D1
MUC 204 FD	20	47	17	31,00	12,70	29,00
MUC 205 FD	25	52	17	34,10	14,30	34,00
MUC 206 FD	30	62	19	38,10	15,90	40,50
MUC 207 FD	35	72	20	42,90	17,50	48,00
MUC 208 FD	40	80	21	49,20	19,00	53,00

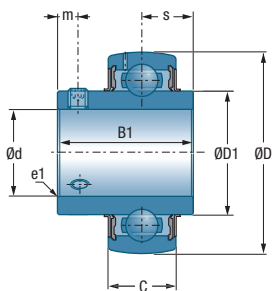

Main dimensions [mm]				Load rating				Max. speed limit	Total weight		Unit
m	e1			C_r (dyn.)	C_{Or} (stat.)		rpm	lbs	kg	Bearings	
inch	mm	inch	mm	lbf	[kN]	lbf	[kN]				
0,177	4,5	0,039	1,0	2 450	10,90	1 190	5,30	7 400	0,400	0,181	MUC 202-10 FD
0,177	4,5	0,059	1,5	2 450	10,90	1 190	5,30	7 400	0,350	0,159	MUC 204-12 FD
0,197	5,0	0,059	1,5	2 680	11,90	1 420	6,30	6 200	0,400	0,181	MUC 205-16 FD
0,197	5,0	0,059	1,5	3 750	16,70	2 030	9,00	5 300	0,680	0,308	MUC 206-18 FD
0,197	5,0	0,059	1,5	3 750	16,70	2 030	9,00	5 300	0,680	0,308	MUC 206-19 FD
0,197	5,0	0,059	1,5	3 750	16,70	2 030	9,00	5 300	0,680	0,308	MUC 206-20 FD
0,236	6,0	0,079	2,0	4 950	22,00	2 770	12,30	4 500	1,06	0,480	MUC 207-20 FD
0,236	6,0	0,079	2,0	4 950	22,00	2 770	12,30	4 500	1,06	0,480	MUC 207-22 FD
0,236	6,0	0,079	2,0	4 950	22,00	2 770	12,30	4 500	1,06	0,480	MUC 207-23 FD
0,315	6,0	0,079	2,0	5 600	24,90	3 210	14,30	4 000	1,37	0,621	MUC 208-24 FD

Main dimensions [mm]		Load rating x 1000 newtons		Max. speed limit	Total weight	Unit
m	e1	C_r dyn.	C_{Or} stat.	rpm	kg	Bearings
4,50	1,5	10,90	5,30	7 400	0,16	MUC 204 FD
5,00	1,5	11,90	6,30	6 200	0,19	MUC 205 FD
5,00	1,5	16,70	9,00	5 300	0,31	MUC 206 FD
6,00	2,0	22,00	12,30	4 500	0,48	MUC 207 FD
8,00	2,0	24,90	14,30	4 000	0,62	MUC 208 FD

